



*The Difference
Is Performance!*



2025

**PRODUCT
CATALOG**

WARRANTY INFORMATION



The Difference Is Performance!

KEG Technologies offers a limited lifetime warranty on tools and items manufactured by KEG. This warranty applies against manufacturing defects.

Limited warranties exist on all bodies, inserts, and components. KEG will not warranty against

loss, failure and/ or damage due to: improper set-up, improper assembly, abnormal wear, improper use, use outside the design parameters of these tools, unauthorized modification of these tools, or failure to perform recommended maintenance on said tools.

Our Standards on Warranties Are What You Should Expect in the Industry!

- 100% MONEY BACK GUARANTEE ON ALL PRODUCTS in the first 90 Days
- 5-year guarantee on titanium ceramic inserts
- 3-year guarantee on all tool bodies with replaceable titanium ceramic inserts
- 1-year guarantee on camera nozzles
- 1-year guarantee on replaceable steel inserts
- 1-year guarantee on all tool bodies with replaceable steel inserts
- 2-year guarantee on chain cutter fins and tube assemblies
- 2-year guarantee on rotating bodies (chain cutter and rotor nozzles)
- 1-year guarantee on-chain cutter skirts and distance plates
- 1-year guarantee on swivels (when shipped with original tool)
- 1-year guarantee on Tier One Nozzles, Steel Inserts and Holders
- 180 days guarantee on re-manufactured tools
- 90 days guarantee on new replacement warranty items

TIER THREE FLUID MECHANICS

KEG FLUID MECHANICS

The National Association of Sewer Service Companies (NASSCO) and its NASSCO Jetter Code of Practice Publication have determined that nozzles with an efficiency rating of 80% and higher are known as a Tier Three Nozzles classification.

Many of our KEG Nozzles exceed efficiency ratings of 95% and thus provide a powerful, long-lasting, and cost-effective product.

Important Note: Our Three Tier products are easily found throughout the KEG catalog with a page side tab and a symbol that denotes specific nozzles classified as a Tier Three Nozzle. Many of our nozzles are marked throughout the catalog with a seal of authentic marked with the 'Tier Three Fluid Mechanics' symbol. For instance, our Royal and Torpedo nozzles achieve 98% and 97% efficiency, and for that are recognized as a 'Tier Three Fluid Mechanics.'





The Difference Is Performance!

TABLE OF CONTENT

The Difference Is In Performance - KEG Technologies

Warranty Information & Keg Fluid Mechanics	Page 1	Aqua Power 700 Nozzle	Page 37
Table of Contents	Page 2	Aqua Power Junior Nozzle	Page 38
KEG Product Training & On-Site Demonstrations	Page 3	Aqua Power Mini Nozzle	Page 39
Flow Meter Assembly	Page 4	Commander Rotor Nozzle	Page 40
PRODUCTS		Duce Nozzles	Page 41
Cleaning Nozzle Family	Page 5	Duce Recycling Nozzles	Page 42
Aluminum VS		Chain Cutter Family	Page 43
Stainless Steel Nozzles	Page 6	Turbo and Micro Chain Cutters	Page 44
Aluminum Nozzles	Page 7	Mini Chain Cutter	Page 45
Traction Nozzles	Page 8	Super Cutter Plus 150	Page 46
Cleaning Nozzle Family	Page 9	Super Cutter Plus 200	Page 47
Torpedo Nozzles	Page 10	Supernova 4000	Page 48
Royal Nozzles	Page 11	Supernova Recycler	Page 49
Sewer Nozzles	Page 12	Adjustable Turbo Cutter	Page 50
Sewer Flush Nozzles	Page 13	Ejector Nozzles	Page 51
Egg Nozzles	Page 14	Hydro Excavation Nozzles	Page 52
Ball Nozzles	Page 15	Hand Injector Hydro Nozzles	Page 53
Standard Nozzles	Page 16	Triple Edge Quattro Hydro Nozzles	Page 54
Penetrating Nozzle Family	Page 17	Twister Hydro Nozzles	Page 55
OMG Nozzles	Page 18	Nozzle Kits and Custom Kits	Page 56-57
OMG Twin Nozzles	Page 19	Kleen Sight 3.0 Camera Nozzle	Page 58-59
Stallion Nozzles	Page 20	Expansion Kits	Page 60-61
Rambo Nozzles	Page 21	ACCESSORIES	
Egg Devastator Nozzles	Page 22	Replaceable Inserts	Page 62
Triple Edge Quattro Nozzles	Page 23	Rambo Tips/ HP Swivels	Page 63
Drill Point Quattro Nozzles	Page 24	Skids	Page 64-66
Twister Nozzles	Page 25	Skids with Holes	Page 67
Forward Jet Nozzles	Page 26	Leader Hose/ Tyger Tail	Page 68
Floor Cleaner Family	Page 27	Bushings/Aqua Sleeves	Page 69
Floor Cleaner Models	Page 28	AntiHook/ Fire Hose	Page 70
Twin Floor Cleaners	Page 29	Chainbreaker/ Chains	Page 71
Floor Cleaner Highrise Skids	Page 30	Channel Cleaner	Page 72
Finishing Nozzle Family	Page 31	Spreader Bar, Angle Adapter, and Y Connector	Page 73
Rotor Nozzles	Page 32	Flow Meter Accessories	Page 74
Specialty Nozzle Family	Page 33	Turbo Adaptor, Clevis Hooks, and Eye Hooks	Page 75
Specialty Nozzle Family	Page 34	Twister Rebuild Kit	Page 76
Equalizer Nozzles	Page 35	Regional Contact Info	Page 78
Toilet Tamer Nozzles	Page 36		

Extreme pipe cleaning power with high efficiency fluid mechanics

KEG'S PRODUCT TRAINING

The Difference is Performance!



The Difference Is Performance!

Are you or your team in need of nozzle training?

Our training course consists of one full 8 hour day of training. The training is broken down into three and a half hours of class time, one and a half hours for truck demonstrations, and two hours of field application. KEG's training course can accommodate up to 20 crew members per training session. Along with the invaluable training and field application, we include a continental breakfast and catered onsite lunch.

We have developed our training course to help you grow and develop your jetting equipment operators into more efficient, safe, and knowledgeable personal. As an additional benefit, you will receive a \$750 dollar credit of the training course back if you purchase any KEG equipment within six months of the training session. Because KEG believes continued education is a necessity in our ever-changing industry, each attendee completing the KEG training course will receive a certificate of completion at the end of the session.

If you are interested in scheduling training for your team or have additional questions, reach out to your local KEG Sales Manager!

We look forward to working with you and your team, enhancing skills and providing knowledge that will take your organization to the next level.

TRAINING BENEFITS

- Comprehensive Industry Training
- Continental Breakfast and Onsite Catered Lunch
- Hands-on Training in Class and Field
- 0% Sales and 100% Training Instruction
- Certificate of Completion for All Attendees

Is your organization or team interested in a demonstration? Reach out to our team.

ON SITE DEMONSTRATIONS

KEG Technologies is committed to providing our customers with the highest quality products and very best customer service. We stand behind our products and through supported continuous education as we advance with technology improvements.

KEG Technologies is dedicated to providing superior customer support through demonstrations and training for all of our quality products.

KEG guarantees that all of our quality products perform as advertised. We will provide field demonstrations as requested to ensure your complete satisfaction!

FLOW METER ASSEMBLY

Essential tools to diagnose, troubleshoot and perform any size project

Our Flow Meter Tube Assembly is a tool designed to diagnose, troubleshoot, and test jetters, and nozzles. The purpose of testing before performing any pipe cleaning is to confirm that all equipment is operating as designed. This tool informs the operator of water flow and allows troubleshooting as needed for nozzles or the jetter.

Benefits to testing and troubleshooting the jetter, either truck or trailer, confirms that the equipment is in proper operating order as designed and provides a reading of flows and pressures.

The Flow Meter Tube Assembly mounts on to the hitch of a pickup truck or similar vehicle with a hitch ability. The assembly is designed to be used as needed in-field operation and can be set up within minutes.

The Flow Meter's digital readout provides precise, result readings for easy to understand results. The Flow Meter measures the water flow to the hundredth of a gallon providing the most accurate results and accounts for as much water as possible. Any style of KEG Nozzle can be used with the Flow Meter. However, for safety reasons, it is not recommended that chain cutters and Duce Nozzles are tested within the assembly.



ASSEMBLY INCLUDES

- Hitch Attachment
- Digital Flow Meter
- Pressure Gage
- Clear Acrylic Tube



FLOW METER ASSEMBLY

Product Shown Above	Part Number	Hose Size	Weight (pounds)	Dimensions
A	FlowMeterAssembly	1/2"-1 1/4"	60	48" x 8"



CLEANING NOZZLE FAMILY

The Difference Is Performance!

Go-To Nozzles For Everyday Use

Our Cleaning Nozzle Family provides several nozzles that vary in use designed to aid the operator in routine pipe cleaning and maintenance applications. KEG Nozzles offer unique jet angles, quantities, and locations, purposely designed to assist in pipe cleaning needs ranging from 2" to 48". The tier rating chart outlines the nozzles available along with an overview rating for usage. For further information regarding each available nozzle, review individual nozzle specifications and applications to select the right tool for your project and budget!

The following forward nozzles are versatile in their use:

- Traction Nozzle
- Egg Nozzle
- Standard Nozzle

A blank inserted into the Forward Jet allow these nozzles to be used as a Cleaning Nozzle. By removing the blank and inserting a forward jet insert enables the penetrating usage for these nozzles increasing their functionality.

TIER THREE FLUID MECHANICS

Most Efficient & Most Powerful Fluid Mechanics, Longest Life Span



Royal Nozzle



Torpedo Nozzle



Sewer Nozzle



Cleaning Nozzle



Traction Nozzle

TIER TWO

Better Efficiency, Longer Life Span

TIER ONE

Lower Efficiency, Shorter Life Span



Egg Nozzle



Sewer Flush Nozzle



Standard Nozzle



Ball Nozzle

ALUMINUM VS STAINLESS STEEL NOZZLES

Benefits and Disadvantages of Each

These nozzles are the same, except for the materials that are used to make them.

The use of either nozzle, as long as they are centered within the pipe, will produce more effective results. If the nozzle is not centered, we will not be able to ensure maximum performance and premature wear. Aluminum nozzles must be run on skids; if not, the warranty will be voided.

Aluminium Nozzle



Stainless Steel Nozzle

You Can't Go Wrong With A Cleaning Family Nozzle!

ALUMINUM BENEFITS:

Aluminum Nozzles; see below for nozzle listing.

Only available in 1" nozzles however, a bushing will allow for multiple size applications from a 1/2" up to 1 1/4".

NOZZLES:

- Traction Nozzle
- Cleaning Nozzle
- Torpedo Nozzle
- Toilet Tamer Nozzle
- Royal Nozzle

Please see our accessories pages for additional product options.

ADVANTAGES:

- **SANITARY, STORM**
- Lighter Weight
- Less Drag in the Pipe
- Water is Distributed Within the Pipe
- Uses Less Water
- Less Wear and Tear on the Equipment
- Less Time

DISADVANTAGES:

- Must Use Skids
- Softer Material

STAINLESS STEEL BENEFITS:

Stainless Steel Nozzles; see below for nozzle listing. Available in 3/8" up to 1 1/2" nozzles.

NOZZLES:

- | | |
|---|--|
| <ul style="list-style-type: none"> • Ball Nozzle • Standard Nozzle • Forward Jet Nozzle • Egg Nozzle • Egg Devastor Nozzle • Sewer Nozzle • Sewer Flush Nozzle • Royal Nozzle | <ul style="list-style-type: none"> • Torpedo Nozzle • Toilet Tamer Nozzle • Cleaning Nozzle • Traction Nozzle • OMG Nozzle • Stallion Nozzle • Rambo Nozzle • Triple Edge Quarto Nozzle • Drill Point Quarto Nozzle |
|---|--|

Please see our accessories pages for additional product options.

ADVANTAGES:

- **SANITARY, STORM**
- Durability
- More Water Proficient Than Tier One and Tier Two Nozzles
- Longer Lasting Equipment
- Time-Efficient

DISADVANTAGES:

- Weight can Create Drag
- Disadvantage when Climbing Hills Through Piping

ALUMINIUM NOZZLES

Light Weight and Highly Efficient



The Difference Is Performance!

KEG's Aluminum Nozzles are lighter to handle and have the same significant advantages and applications as the nozzles made of Stainless Steel. The KEG Aluminum Nozzles are available in Traction, Cleaning, Torpedo, and Royal Nozzle models only. These nozzles are offered through a 1" hose connections, but can be adapted to 1/2", 3/4" and 1 1/4" hoses. Please see our accessories pages for product options and nozzle capabilities.

An aluminum nozzle being used with a centering skid will produce 25% more power than a stainless steel dragging nozzle using the same flows and pressures. Aluminum nozzles further enable the operator to save water, time and reduce machinery operating hours through the use of a lighter nozzle, centered in the pipe.



Our standard warranty ONLY applies to aluminum nozzles when used with a skid.

Product Shown Above	Part Number	Hose Size	Number of Inserts	Insert Size	Weight (pounds)	Dimensions	Pipe Size
A: Traction	107015	1"	6 Rear, 1 Front	M8	1.25	Same as Steel	4" to 10"
B: Cleaning	107003	1"	8 Rear	M8	2.15	Same as Steel	4" to 16"
C: Torpedo	107031	1"	8 Rear	M14	5.2	Same as Steel	6" to 16"
D: Toilet Tamer	100115WAA	1"	6 Rear 1 Front	M8	1.5	Same as Steel	4" to 12"
E: Royal	107021	1"	12 Rear	M14	7.2	Same as Steel	12" to 48"

Please indicate "-C" for titanium ceramic inserts or "-S" for steel inserts after each part number -
All replaceable forward jet nozzles now come with an additional blank steel insert included.



The Difference Is Performance!

TRACTION NOZZLE

Tight water pattern for efficient cleaning and pulling

TIER THREE FLUID MECHANICS

The Traction Nozzle is an excellent multi-purpose nozzle. When an extremely tight water pattern is needed for intense directed cleaning and propulsion; few nozzles perform as well as KEG's Traction Nozzle. With 8° and 12° angled jets, the Traction Nozzle will provide tremendous thrust and highly efficient cleaning using KEG's Fluid Mechanics.

An optional forward penetrating jet can turn the Traction Nozzle into an efficient penetrating nozzle to blast sand and mud or to create a pathway through heavy debris for other KEG Nozzles to be used in the pipe.

The 7 insert set-up (6 rear, 1 forward) can be configured in steel or titanium ceramic. The Traction, is a Tier Three Nozzle, features KEG's highest performing fluid mechanics and is over 80% efficient!

Optional Forward Penetrator



6 rear Jets at 8° and 12°

Extreme pipe cleaning power with high efficiency fluid mechanics

ADVANTAGES

- 80+% efficiency, Tier Three Nozzle
- 8° and 12° Alternating Jet Angles
- Penetrator and/or Cleaning Nozzle
- Replaceable Threaded Inserts
- This is a great nozzle for recycled water trucks!

APPLICATIONS

- **SANITARY, STORM**
- Clears Path for Other Nozzles
- Gentle on Deteriorated Pipe
- Mud & Sand Removal



A



B



C



D

* See accessories section for Pulling Eye Option and other available products sold separately.

Product Shown Above	Part Number	Hose Size	Number of Inserts	Insert Size	Weight (pounds)	Dimensions	Pipe Size
A	100009	3/8"	6 Rear, 1Front	M6	.6	2" x 1 1/2"	2" to 6"
B	100011	1/2"	6 Rear, 1Front	M6	.6	2" x 1 1/2"	2" to 6"
C	100013	3/4"	6 Rear, 1Front	M8	2.5	4" x 2 3/8"	3" to 8"
D	100015	1"	6 Rear, 1Front	M8	3.5	4 1/4" x 2 3/4"	4" to 12"
D	100017	1 1/4"	6 Rear, 1Front	M8	6	5" x 3"	4" to 12"

Please indicate "-C" for titanium ceramic inserts or "-S" for steel inserts after each part number -

CLEANING FAMILY

Excellent efficiency for general purpose cleaning



The Difference Is Performance!

KEG's Cleaning Nozzle is a high-efficiency everyday workhorse nozzle suitable for all-around cleaning of 4" to 16" lines. Utilizing eight threaded inserts with angles of 15° and 25°, the Cleaning Nozzle will give the operator efficiency above 80%.

The Cleaning Nozzle also is available in a wide-angle version. This nozzle has all the advantages of the 15°/25°, but with wider 25° and 40° degree jet pattern, it gives it the capability of cleaning pipes up to 40". The best application for this nozzle is shallow lines that have blowback and heavy grease.

KEG's Cleaning Nozzle is also available in 3/8" and 1/2" configurations, giving the small jetter operator the advantage of fluid mechanics not ordinarily available in other smaller nozzles.



8 Jets at 15° and 25° or 25° and 40°

ADVANTAGES & APPLICATIONS

- **SANITARY, STORM**
- 80+% Efficiency, Tier Three Nozzle,
- 15°/25° or 25°/40° Alternating Jet Angles
- Durable Nozzle For Everyday General Cleaning
- High Wall Force Cleaning
- Wide Angles Reduce Air Draw
- Replaceable Threaded Inserts
- This is a great nozzle for recycled water trucks!

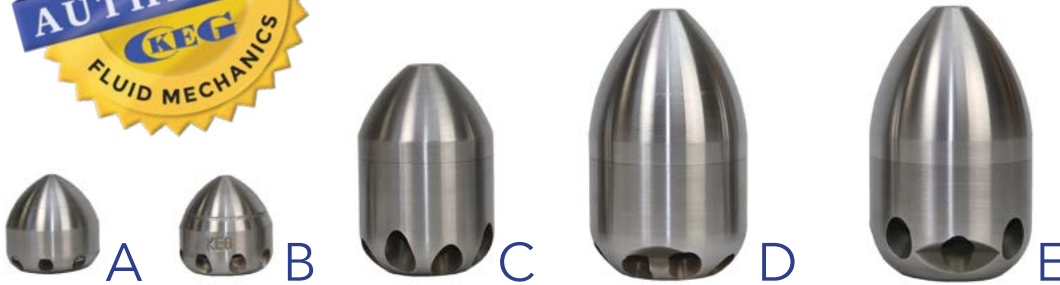

Product Shown Above	Part Number	Hose Size	Number of Inserts	Insert Size	Weight (pounds)	Dimensions	Pipe Size
A	100004	3/8"	8 Rear	M6	.7	1.8" x 1 3/4"	3" to 8"
B	100001	1/2"	8 Rear	M6	.9	1.8" x 1 3/4"	3" to 8"
C	100002	3/4"	8 Rear	M8	4.4	4" x 2 1/2"	4" to 12"
D	100003	1"	8 Rear	M8	6.6	5" x 3"	4" to 16"
D	100005	1 1/4"	8 Rear	M8	6.6	5" x 3"	4" to 16"

KEG WIDE ANGLE CLEANING NOZZLE

E	101103	1"	8 Rear	M8	6.6	5" x 3"	4" to 40"
---	--------	----	--------	----	-----	---------	-----------

Please indicate "-C" for titanium ceramic inserts or "-S" for steel inserts after each part number - All replaceable forward jet nozzles now come with an additional blank steel insert included.



The Difference Is Performance!

TORPEDO NOZZLE

Extreme pipe cleaning power with high efficiency fluid mechanics

TIER THREE FLUID MECHANICS

With its aerodynamic shape and hefty mass, the Torpedo Nozzle does indeed resemble something fired by the US Navy. This, in conjunction with its superior fluid mechanics, allows the Torpedo to stay in the bottom of a pipe, providing steady, high efficiency pipe cleaning.

This nozzle is suitable for pipes from 6" to 16", however, it can be used for pipe as large 32". It is noted that the larger the pipe, the water impact will be comprised. The Torpedo Nozzle will provide unequalled cleaning power for the operator and will save fuel, water, and man-hours. Our customers depend on the Torpedo Nozzle as one powerful cleaning tool that pays for itself over and over again.

The 8 insert set-up can be configured in steel or titanium ceramic. The Torpedo is a Tier Three Nozzle, features KEG's highest performing fluid mechanics and is over 95% efficient!



8 Jets at 12° and 18°

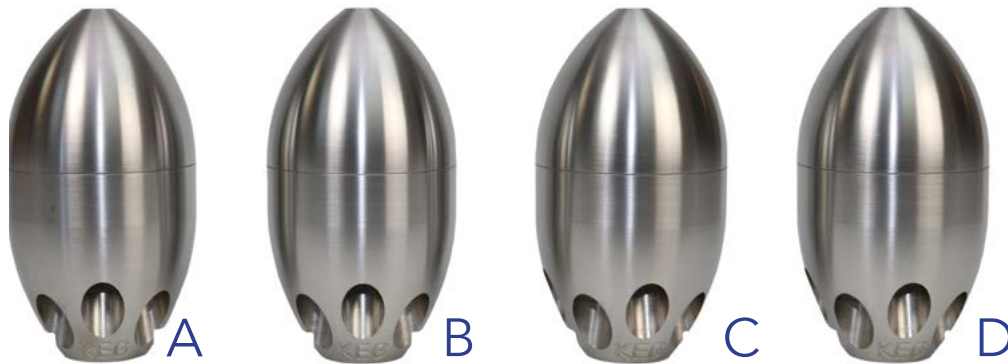

ADVANTAGES

- 95+% Efficiency, Tier Three Nozzle
- 12° and 18° Alternating Jet Angles
- Extreme Cleaning Power
- Saves Time, Water & Energy
- Replaceable Threaded Inserts
- This is a great nozzle for recycled water trucks!

APPLICATIONS

- **SANITARY, STORM**
- All Around Cleaning
- Heavy Debris Removal
- Everyday Nozzle
- Pipes 6" and larger

KEG TORPEDO NOZZLE

Product Shown Above	Part Number	Hose Size	Number of Inserts	Insert Size	Weight (pounds)	Dimensions	Pipe Size
A	100030	3/4"	8 Rear	M14	14	7" x 3 1/2"	6" and up
B	100031	1"	8 Rear	M14	14	7" x 3 1/2"	6" and up
C	100032	1 1/4"	8 Rear	M14	14	7" x 3 1/2"	6" and up
D	100033	1 1/2"	8 Rear	M14	14	7" x 3 1/2"	6" and up

Please indicate "-C" for titanium ceramic inserts or "-S" for steel inserts after each part number



The Difference Is Performance!

ROYAL NOZZLE

Maximum cleaning power in large diameter pipes

The Royal Nozzle, because of its wider angles, is more diverse, because it allows more penetrating power to clean pipes better than other nozzles. With 12 alternating jets at 22° and 32°, the Royal Nozzle is designed for all-around cleaning of pipes up to 48" in diameter.

The sheer weight of the Royal Nozzle keeps it on the bottom of the pipe for effective cleaning when other nozzles are flailing about wasting water.

The 12 insert set-up can be configured in steel or titanium ceramic. The Royal is a Tier Three Nozzle, features KEG's Highest Performing Fluid Mechanics, and is over 95% efficient!



12 Jets at 22° and 32°

ADVANTAGES

- 95+% Efficiency, Tier Three Nozzle
- 22° and 32° Alternating Jet Angles
- High Wall Force in Large Diameter Pipes
- Reduced Water & Energy Consumption
- Time Saving
- Replaceable Threaded Inserts

APPLICATIONS

- **SANITARY, STORM**
- General Sewer Cleaning
- Heavy Debris Removal
- Mud & Sand
- Pipes 12"-48"



A



B



C



D

KEG ROYAL NOZZLE

Product Shown Above	Part Number	Hose Size	Number of Inserts	Insert Size	Weight (pounds)	Dimensions	Pipe Size
A	100020	3/4"	12 Rear	M14	17.6	7 1/2" x 4 3/8"	12" to 48"
B	100021	1"	12 Rear	M14	17.6	7 1/2" x 4 3/8"	12" to 48"
C	100022	1 1/4"	12 Rear	M14	17.6	7 1/2" x 4 3/8"	12" to 48"
D	100023	1 1/2"	12 Rear	M14	17.6	7 1/2" x 4 3/8"	12" to 48"

Please indicate "-C" for titanium ceramic inserts or "-S" for steel inserts after each part number

Call toll free to order 1.866.595.0515

kegnozzles.com | KEGGMBH



The Difference Is Performance!

SEWER NOZZLE

Excellent efficiency for larger sanitary and storm lines

TIER THREE FLUID MECHANICS

Available for hoses from 3/4" through 1 1/2", KEG's Sewer Nozzle is truly a "Heavy Weight" in the sewer and storm water cleaning industry. The Sewer Nozzle ranges in weight from 17 to 22 pounds and is sure to stay centered in the bottom of the pipe for effective cleaning action.

The 15° and 20° jet angles give the operator high wall force with a wide water pattern necessary to clean large diameter pipes of buildup and debris. The 10 or 12 insert set-up can be configured in steel or titanium ceramic. The Sewer Nozzle is a Tier Three Nozzle, and is over 80% efficient!



10 or 12 Jets at 15° and 20°

ADVANTAGES

- 80+% Efficiency, Tier Three Nozzle
- 15° and 20° Alternating Jet Angles
- Heavy Dragging Nozzle
- High Wall Force Cleaning
- Replaceable Threaded Inserts
- This is a great nozzle for recycled water trucks!

APPLICATIONS

- **SANITARY, STORM**
- General Sewer Cleaning
- Pipes up to 24"
- Larger Hose Diameters

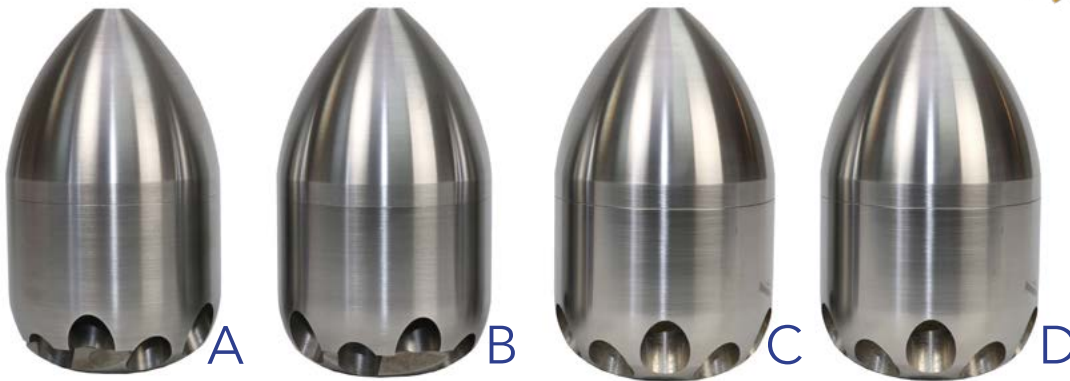

KEG SEWER NOZZLE

Product Shown Above	Part Number	Hose Size	Number of Inserts	Insert Size	Weight (pounds)	Dimensions	Pipe Size
A	100040	3/4"	10 Rear	M14	17.6	7" x 3 1/2"	6" to 24"
B	100041	1"	10 Rear	M14	17.6	7" x 3 1/2"	6" to 24"
C	100042	1 1/4"	12 Rear	M14	22	8 1/4" x 4 3/8"	6" to 24"
D	100043	1 1/2"	12 Rear	M14	22	8 1/4" x 4 3/8"	6" to 24"

Please indicate "-C" for titanium ceramic inserts or "-S" for steel inserts after each part number

Call toll free to order 1.866.595.0515

kegnozzles.com | KEGGMBH

SEWER FLUSH NOZZLE

Excellent efficiency for a competitive price



The Difference Is Performance!

KEG's Sewer Flush Nozzle is a heavy duty cleaning nozzle that provides superior results while being more cost competitive. The power of the Sewer Flush's 15 and 25 degree jet angles gives the operator high wall force with a wide water pattern

necessary to clean large diameter pipes. The Sewer Flush Nozzle is available with replaceable steel or titanium ceramic inserts and is an excellent mid-range complement to the other products in KEG's Cleaning Nozzle Family.

ADVANTAGES

- 15° and 25° Dual Jet Angles
- Cost Competitive Tier Two Nozzle
- Replaceable Threaded Inserts
- High Wall Force Cleaning
- Heavy Dragging Nozzle

APPLICATIONS

- **SANITARY**
- Pipes up to 24"
- General Sewer Cleaning
- Fits 0.375" - 1.25" Hose



Rear Jets at 15° and 25°



KEG SEWER FLUSH NOZZLE

Product Shown Above	Part Number	Hose Size	Number of Inserts	Insert Size	Weight (pounds)	Dimensions	Pipe Size
A	100100-S	1/4"	4 Rear 1 Forward	M5	.15	1" x 7/8"	From 2"
B	100098-S	3/8"	5 Rear	M5	.15	1" x 1"	From 3"
C	100101	1/2"	5 Rear	M6	.6	2 1/10" x 1 1/2"	From 3"
D	100102	3/4"	8 Rear	M8	3.25	3 7/8" x 2 1/2"	From 4"
E	100113	1"	10 Rear	M8	13.7	6" x 3 1/2"	From 6"
E	100104	1 1/4"	12 Rear	M14	13.7	7" x 3 7/8"	From 8"

Please indicate "-S" for steel forward jet insert after each part number - all replaceable forward jet nozzles now come with an additional blank steel insert included.



The Difference Is Performance!

EGG NOZZLE

Light and agile all-around cleaning nozzle

This Egg Nozzle is an upgrade from the Standard Nozzle. Instead of drilled jets, it comes with replaceable inserts available in either steel or titanium ceramic.

ADVANTAGES

- Optional Penetrating Jet
- Cost Competitive Tier Two Nozzle
- Available with 15 Degree or 30 Degree Jets
- Replaceable Inserts Prolong Nozzle Life
- Wear Resistant
- Made of 300 Series Hardened Stainless Steel



APPLICATIONS

- **SANITARY**
- Residential Applications
- Flushing (15 Degree)
- Cleaning (30 Degree)



KEG EGG NOZZLE

Product Shown Above	Part Number	Hose Size	Number of Inserts	Insert Size	Weight (pounds)	Dimensions	Pipe Size
A	100211	3/8"	6 Rear 1 Forward	M5	.6	2" x 1 1/2"	2" to 6"
B	100212	1/2"	4 Rear 1 Forward	M6	.6	2" x 1 1/2"	2" to 6"
C	100213	3/4"	4 Rear 1 Forward	M6	2.5	4" x 2 3/8"	3" to 8"
D	100214	1"	4 Rear 1 Forward	M8	3.2	4 1/4" x 2 3/4"	4" to 10"
E	100215	1 1/4"	6 Rear 1 Forward	M8	2.3	5" x 3"	4" to 12"

Please indicate "-C" for titanium ceramic inserts or "-S" for steel inserts after each part number - All replaceable forward jet nozzles now come with an additional blank steel insert included.

BALL NOZZLE

Rounded edges for easy maneuverability and ideal for cleaning service laterals

Ball Nozzles are KEG's Tier One Nozzles that come with factory drilled orifices. For small, residential applications, these nozzles are typically used. Ball Nozzles have a one year warranty.

KEG's Ball Nozzles are suitable for pipes from 1" to 8". It is noted that in larger pipe the water impact will be reduced. The Ball Nozzle fits a 1/4", 3/8" and 1/2" hose.



ADVANTAGES

- Optional Forward Jet
- Wear Resistant
- Cost Competitive Tier One Nozzle
- Rounded Edges

APPLICATIONS

- **SANITARY**
- Optional Forward Jet
- Residential Applications
- Services & Laterals



A



B



C

KEG BALL NOZZLE

Product Shown Above	Part Number	Hose Size	Number of Inserts	Insert Size	Weight (pounds)	Dimensions	Pipe Size
A	100113	1/4"	4 Rear 1 Forward	Drill	.1	1" x 7/8"	From 1"
B	100115	3/8"	4 Rear 1 Forward	Drill	.1	1" x 1"	From 2"
C	100117	1/2"	5 Rear 1 Forward	Drill M6	.2	1 1/4" x 1 1/4"	From 3"

Please indicate "-S" for steel forward jet insert after each part number - all replaceable forward jet nozzles now come with an additional blank steel insert included.



The Difference Is Performance!

STANDARD NOZZLE

Small, maneuverable nozzles suitable for residential sewer cleaning applications

Standard Nozzles are KEG's Tier One Nozzles that come with factory drilled orifices. For small, residential applications, these nozzles are typically used. Standard Nozzles have a one year warranty. Standard Nozzles fit 1/4" to 1 1/4" hoses and will work effectively in 2" to 12" lines.

ADVANTAGES

- Optional Forward Jet
- Wear Resistant
- Cost Competitive

APPLICATIONS

- **SANITARY**
- Optional Forward Jet
- Wear Resistant
- Cost Competitive



A



B



C



D



E

KEG STANDARD NOZZLE

Product Shown Above	Part Number	Hose Size	Number of Inserts	Insert Size	Weight (pounds)	Dimensions	Pipe Size
A	100085	1/4"	3/4 Rear	Drill	.1	1" x 1"	2" to 4"
B	100083	3/8"	4 Rear	Drill	.1	1" x 1"	2" to 4"
C	100087	1/2"	5 Rear 1 Forward	Drill/M6	.3	2" x 1 1/4"	3" to 6"
D	100091	1"	5 Rear 1 Forward	M6	1.3	3 1/4" x 2"	4" to 10"
E	100093	1 1/4"	5 Rear 1 Forward	M6	2.2	3 3/4" x 2 3/8"	5" to 12"

Please indicate "-S" for steel forward jet insert after each part number -all replaceable forward jet nozzles now come with an additional blank steel insert included.

PENETRATING NOZZLE FAMILY



The Difference Is Performance!

Designed to handle the toughest clogs and obstructions!

When the toughest clogs and obstructions are encountered in a sewer line, KEG recommends our Tier Three Penetrating Nozzles; OMG, Stallion, or Traction for more challenging blockages when

efficiency is a factor. For total blockages caused by roots, grease, or other impediments to flow, choose one of our Penetrating Nozzles available in sizes from 1/4" to 1 1/4".

TIER THREE EFFICIENCY

*Heavy debris removal;
Gentle on pipe walls*

- OMG NOZZLE**
- STALLION NOZZLE**
- TRACTION NOZZLE**



TIER TWO EFFICIENCY

**TRIPLE EDGE
QUATTRO NOZZLE**
Good Thrust, Forward Jets

**DRILL POINT
QUATTRO NOZZLE**
Better Thrust, Drill Point

RAMBO NOZZLE
Best Penetrating Nozzle in the Industry!



TIER ONE EFFICIENCY

*Penetrating and flushing in
small to medium pipe.*



BALL NOZZLE



FORWARD NOZZLE

STANDARD NOZZLE





The Difference Is Performance!

O.M.G. NOZZLE

For cleaning commercial pipe where pressure on the pipe wall is not desirable

The OMG Nozzle is a Tier Three Fluid Mechanics large nozzle suitable for storm drain or sewer cleaning applications where pipe walls may be compromised and pressure on the pipe wall is not desired. The OMG is ideal for cleaning deteriorated pipe, corrugated metal pipe, or concrete pipe.

The OMG Nozzle offers superior performance in damaged or deteriorated pipe. The Tier Three design offers the ability to separate water coming into the nozzle and water coming from the nozzle. The large shape and design of the OMG provides optimal cleaning with minimal to no damage to the integrity of the pipe.

The OMG Nozzle is available with 13 titanium ceramic inserts. It has 12 jets; six jets at 8 degrees, and six jets at 12 degrees with an optional forward zero-degree jet. A blank can be inserted to remove flow in the forward jet.



ADVANTAGES

- Tier Three Efficiency & Power
- High Thrust with 8° & 12° Jets
- Long Design Spans Holes in Pipe
- Minimal Force on Pipe Wall
- Replaceable Inserts

APPLICATIONS

- **SANITARY, STORM**
- Pipe with No Bottom
- Concrete & Corrugated Metal
- Penetrating, Flushing, Pulling
- Clearing a Path for Other Nozzles

* See accessories section for Pulling Eye Option and other available products sold separately.

Product Shown Above	Part Number	Hose Size	Number of Inserts	Insert Size	Weight (pounds)	Dimensions	Pipe Size
A	100266	1"	12 Rear 1 Forward	M14	36	18 1/4" x 4 1/4"	12" and up
B	100267	1 1/4"	12 Rear 1 Forward	M14	36	18 1/4" x 4 1/4"	12" and up

The OMG Nozzle is only available with titanium ceramic inserts



The Difference Is Performance!

O.M.G. NOZZLE TWINS

For cleaning commercial pipe where pressure on the pipe wall is not desirable

The OMG Twin Nozzles are a Tier Three Fluid Mechanics large nozzle suitable for storm drain or sewer cleaning applications where pipe walls may be compromised and pressure on the pipe wall is not desired. The OMG Twins are ideal for cleaning deteriorated pipe, corrugated metal pipe, or concrete pipe.

The OMG Twin Nozzles offers superior performance in damaged or deteriorated pipe. The Tier Three design offers the ability to separate

water coming into the nozzles and water coming from the nozzles. The large shape and design of the OMG Twins provide optimal cleaning with minimal to no damage to the integrity of the pipe.

The OMG Twin Nozzles are available with 26 titanium ceramic inserts. It has 24 jets; 12 jets at 8 degrees, and 12 jets at 12 degrees with an optional forward zero-degree jet. A blank can be inserted to remove flow in the forward jet.

ADVANTAGES

- Tier Three Efficiency & Power
- High Thrust with 8° & 12° Jets
- Long Design Spans Holes in Pipe
- Minimal Force on Pipe Wall
- Replaceable Inserts

APPLICATIONS

- **SANITARY, STORM**
- Pipe with No Bottom
- Concrete & Corrugated Metal
- Penetrating, Flushing, Pulling
- Clearing a Path for Other Nozzles



An extra set of inserts are included to run OMG Nozzles independently

KEG O.M.G. TWIN NOZZLES

Product Shown Above	Part Number	Hose Size	Number of Inserts	Insert Size	Weight (pounds)	Dimensions	Pipe Size
A	100266-T	1"	24 Rear 2 Forward	M14	85	48" x 24"	12" and up
B	100267-T	1 1/4"	24 Rear 2 Forward	M14	85	48" x 24"	12" and up

The OMG Twin Nozzles are only available with titanium ceramic inserts. Extra set of inserts are included to run OMG Nozzles independently.



The Difference Is Performance!

STALLION NOZZLE

Excellent for mid to large storm & sanitary lines with heavy debris

The Stallion Nozzle is a Tier Three Fluid Mechanics medium-sized nozzle excellent for storm drain or sewer cleaning applications where pipes are heavily exposed to debris, or where pipes are heavily damaged or weakened.

The Stallion is a fantastic flushing nozzle, however, due to the angle of the jets, the Stallion should not be used to clean large pipe walls. The Stallion Nozzle is ideal for flushing corrugated metal,

concrete, clay, or plastic pipe.

The Tier Three design offers the ability to separate water coming into the nozzle and water coming from the nozzle. The shape and design offers a jet stream ideal for penetrating & flushing debris, or negotiating steep terrain. The Stallion Nozzle is available with titanium ceramic inserts only and has jets at 8° and 12°.

ADVANTAGES

- Tier Three Efficiency & Power
- High Thrust with 8° and 12° Jets
- Long Design Spans Holes in Pipe
- Minimal Force on Pipe Wall
- Replaceable Inserts
- Works easily through misaligned or disjointed pipes.

APPLICATIONS

- **SANITARY, STORM**
- Ability to Clean Weakened Pipe
- Clay, Plastic, Concrete, PVC, Corrugated Metal Pipes
- Penetrating, Flushing, Pulling

A



KEG STALLION NOZZLE WITH FORWARD JET

Product Shown Above	Part Number	Hose Size	Number of Inserts	Insert Size	Weight (pounds)	Dimensions	Pipe Size
A	100264	1"	6 Rear 1 Forward	M8	9.4	12" x 3"	From 6"

The Stallion Nozzle is only available with titanium ceramic inserts

RAMBO NOZZLE

High traction power, drill point
and forward jet features provide maximum clog removal



The Difference Is Performance!

The Rambo Nozzle shares its name with a very “dangerous” warrior of the big screen. However, even the famous movie hero would be hard-pressed to emulate the success this nozzle has in removing its “enemies.” The Rambo Nozzle combines the best characteristics of all penetrating nozzles into a maximum performance, maximum clog busting nozzle with its wedge-shaped design, drill point, and excellent thrust.

The Rambo Nozzle is sure to get you out of a jam at 2 am when flow needs to be restored, and clogs need to be eliminated. The Rambo Nozzle’s unique benefit is that the drill point feature has three rear spraying jets allowing the nozzle to dissolve blockages from within. The Rambo can be configured with steel or titanium ceramic inserts. Drill point can be removed, and a standard M8 can be inserted in its place for 1/2” and up only.

ADVANTAGES

- Three Nozzles in One
- Maximum Penetration
- Replaceable Drill Point
- Replaceable Inserts
- Tier Two Nozzle (3/4”+)



1” Rambo Nozzle

APPLICATIONS

- **SANITARY, STORM**
- Total Blockages
- Roots, Grease, Ice, Stone, Sand, and Rags
- Small to Large Pipes

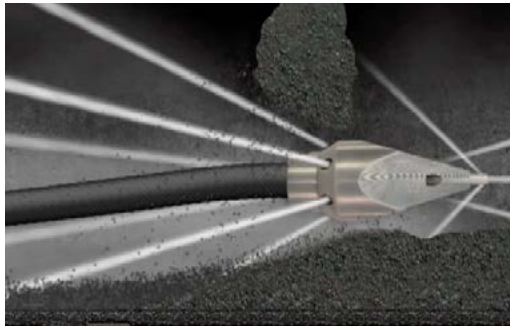

KEG RAMBO NOZZLE

Product Shown Above	Part Number	Hose Size	Number of Inserts	Insert Size	Weight (pounds)	Dimensions	Pipe Size
A	100067	1/4”	Factory	Drill	.1	1 7/8” x 7/8”	From 2”
B	100067A	3/8”	Factory	Drill	.1	1 7/8” x 7/8”	From 2”
C	100066	1/2”	Factory	Drill	.35	3 1/4” x 1 1/4”	From 3”
D	100065	3/4”	5/3/1	M8	1.55	4 7/8” x 2 1/8”	From 3”
E	100063	1”	5/4/1	M8	4.75	6 3/4” x 3”	From 4”
F (Not Shown)	100064	1 1/4”	6/4/1	M8	5.35	7 7/8” x 3”	From 6”

Please indicate “-C” for titanium ceramic inserts or “-S” for steel inserts after each part number.



The Difference Is Performance!

EGG DEVASTATOR NOZZLE

Light and agile all-around cleaning nozzle with penetrating and blockage busting capabilities

The Egg Devastator Nozzle is the perfect combination of the four forward jets and rounded body design makes this an ideal nozzle for total blockage removal in piping with many angles.



4 Forward Jets 3 Rear Jets at 30°

ADVANTAGES

- Multiple Forward Jets
- Cost competitive Tier Two Nozzle
- Available with 30 Degree Jet Angles
- Replaceable Inserts Prolong Nozzle Life
- Wear Resistant
- Made of 300 Series Hardened Stainless Steel

APPLICATIONS

- **SANITARY**
- Residential Applications
- Service Laterals as Well as Mains
- Blockages
- Fits 3/8" - 1 1/4" hose



KEG EGG DEVASTATOR NOZZLE

Product Shown Above	Part Number	Hose Size	Number of Inserts	Insert Size	Weight (pounds)	Dimensions	Pipe Size
	100219-S	3/8"	3 Rear, 4 Forward	Drill	.4	7/8" x 7/8"	From 2"
B	100220	1/2"	3 Rear, 4 Forward	M6	.4	1 3/8" x 3/4"	From 2"
C	100221	3/4"	3 Rear, 4 Forward	M6/M8	.7	1 3/4" x 17/8"	From 3"
D	100222	1"	3 Rear, 4 Forward	M6/M8	1.1	2 3/16" x 1 1/2"	From 4"
E	100223	1 1/4"	3 Rear, 4 Forward	M8	1.1	2 3/4" x 2"	From 4"

Please indicate "-C" for titanium ceramic inserts or "-S" for steel inserts after each part number.

TRIPLE EDGE QUATTRO NOZZLE



The Difference Is Performance!

Reliable obstruction removal with forward jets and sharp edge design

The Triple Edge Quattro Nozzle is an excellent penetrating nozzle for a variety of applications. Deformed pipes, sand, mud, roots, trash, or other blockages inevitably yield to this high-performance nozzle. The combination of four forward jets and sharp edges of the Triple Edge Quattro make it an ideal selection for total blockage removal.

Triple Edge Quattro Nozzles have Tier One and Tier Two efficiency ratings, are manufactured from hardened stainless steel. This nozzle is available with steel or titanium ceramic inserts.



KEG TRIPLE EDGE QUATTRO NOZZLE

Product Shown Above	Part Number	Hose Size	Number of Inserts	Insert Size	Weight (pounds)	Dimensions	Pipe Size
A	100052-S	1/4"	Factory	Drill	.1	1 1/4" x 7/8"	From 2"
B	100050-S	3/8"	Factory	Drill	.1	1 1/4" x 7/8"	From 2"
C	100054-S	1/2"	Factory	Factory	.3	2 3/4" x 7/8"	From 3"
D	100056	3/4"	6 Rear 4 Forward	M6	.8	2 3/4" x 1 3/4"	From 3"
E	100058	1"	5 Rear 4 Forward	M8	1.85	4" x 2 1/2"	From 4"
F	100060	1 1/4"	6 Rear 4 Forward	M8	6	7" x 3"	From 4"

Please indicate "-C" for titanium ceramic inserts or "-S" for steel inserts after each part number.



The Difference Is Performance!

DRILL POINT QUATTRO NOZZLE

Penetrating ability and traction characteristics for tough clogs

The Drill Point Quattro Nozzle is a terrific tool for removing total line blockages. The stainless steel drill tip penetrates the toughest clogs, particularly grease blockages. The three jets pre-drilled in the changeable tip then enlarge the opening in the clog, working with the sharp, tapered edges of the Drill Point Quattro.

The loosened debris is then washed down the line by the propulsion jets at the back of the Drill Point Quattro that provide excellent thrust. For low maintenance, high performance penetrating nozzle, the Drill Point Quattro is hard to beat. The Drill Point Quattro is classified as a Tier One or Tier Two Nozzle depending on the size and the availability of replaceable inserts. Inserts are available in steel or titanium ceramic.



ADVANTAGES

- Replaceable Drill Point
- Excellent Thrust & Traction
- Cost Competitive; Tier One & Tier Two Nozzle
- Replaceable Inserts Available

APPLICATIONS

- **SANITARY**
- Total Blockages
- Grease Penetration
- Pipes from 2"+

KEG DRILL POINT QUATTRO NOZZLE

Product Shown Above	Part Number	Hose Size	Number of Inserts	Insert Size	Weight (pounds)	Dimensions	Pipe Size
A	100051-S	1/4"	Factory	Drill	.2	1 7/8" x 7/8"	From 2"
A	100053-S	3/8"	Factory	Drill	.3	1 7/8" x 7/8"	From 2"
B	100055-S	1/2"	Factory	Drill	.4	2 1/4" x 1 1/4"	From 3"
C	100057	3/4"	6	M6	.8	3 7/8" x 1 7/8"	From 3"
D	100059	1"	6	M6	1.9	4 7/8" x 2 3/8"	From 4"

Please indicate "-C" for titanium ceramic inserts or "-S" for steel inserts after each part number for 3/4" and 1". The 1/2", 3/8", and 1/4" are only offered with factory steel inserts.



The Difference Is Performance!

TWISTER NOZZLE

Oscillating forward jets excellent for hydro excavation and cleaning lines

The Twister Nozzle is an oscillating jet perfect for removing grease and roots or clearing blockages from a pipe.

The four rear jets propel this nozzle up the line while the oscillating forward jet cuts through grease and roots clearing blockages. This nozzle is solely designed to clear blockages in a time-efficient manner.

This nozzle offers longevity as there are replacement parts available. Please see our accessories page for replacement parts.

ADVANTAGES

- Oscillating Front Jet Cleans & Penetrates
- Four Rear Jets can be Plugged or Opened
- Stainless Steel Body

APPLICATIONS

- **SANITARY**
- Excellent for Hydro Excavating



Helpful Tool: Twister Rebuild Kit, See Accessories Pages



KEG TWISTER NOZZLE

Product Shown Above	Part Number	Hose Size	Number of Inserts	Insert Size	Weight (pounds)	Dimensions
A	101320	1/2"	4 Rear/1 Front	M8	.7	2 1/2" x 1 1/2"
B	101321	3/4"	4 Rear/1 Front	M8	1.24	2 5/8" x 2 5/8"
C	101322	1"	4 Rear/1 Front	M8	1.7	3 7/8" x 2 1/8"



The Difference Is Performance!

FORWARD JET NOZZLE

For cleaning of residential services and other lines where a one directional flow of water and debris is necessary

The Forward Jet Nozzle has six factory drilled forward inserts with one center forward interchangeable insert and zero rear inserts. This nozzle is only available in 1/2" connections.

The Forward Jet Nozzle propels water through the forward nozzle and breaks up the clog or pipe obstruction, washing away the debris from the residence.

The configurations are available in two options. Please specify at the time of ordering. The 1.8 configuration is used for lower flow, while the 2.2 configuration is intended for higher flow and provides better control of the nozzle for debris removal.

The maximum recommended pressure for this nozzle is 700 psi for safety reasons.

Technique for using the Forward Jet Nozzle:

The operator should feed the hose into the service lateral by hand, activate the jetter, then force the clog toward the sewer main. When the nozzle returns to the cleanout, shut down the water and repeat the process until the service lateral is clear.

ADVANTAGES

- Moves Debris Away from the Residence or Business
- Cost Effective Tier One Nozzle
- No Back-Flow into the House or Structure
- Wear Resistant

APPLICATIONS

- **SANITARY**
- Residential Applications
- Laterals & Services



A



7 Forward Jets

KEG FORWARD JET NOZZLE

Product Shown Above	Part Number	Hose Size	Number of Inserts	Insert Size	Weight (pounds)	Dimensions	Pipe Size
A	100118-1.8	1/2"	6 Factory/ 1 Center	M6	.2	1 3/8" x 1 1/4"	From 3"
B	100118-2.2	1/2"	6 Factory/ 1 Center	M6	.2	1 3/8" x 1 1/4"	From 3"

Available in two configurations. Please specify at time of ordering.

The maximum recommended pressure for this nozzle is 700 psi for safety reasons.

FLOOR CLEANER FAMILY

Maximum power for large diameter pipe!



The Difference Is Performance!



Storm Water Infrastructure - Evolution of Maintenance Requirements

KEG has long been a leader in developing products for the storm water market. As Federal requirements for greater storm water system monitoring and maintenance grow, storm water departments are facing more and more demands on their budgets, workforce, and expertise. KEG's line of products for storm water line maintenance includes a wide variety of tools, including chain cutters, floor cleaners, and large diameter cleaning nozzles like our Sewer and Royal Nozzles.

Since 2009, KEG has offered our customers storm water packages that include nozzles, floor cleaners, and chain root cutters to cover the gamut of storm system problems. If you are a storm water professional and need help determining affordable solutions to your system's maintenance requirements, call on KEG for innovative products and services. ***We've been there, and we can help!***

** Please see our accessories pages for bolt-on, weld-on roll cage options, bolt-on or weld-on skid options, 45 and 90-degree angle adaptors along with usage and capable information for each available accessory.*

Superior Design Equals Superior Performance

Due to our advanced design fluid mechanics, the flow from the high-pressure water hose is converted to maximum cleaning power in each jet of the floor cleaner. The resulting flow from the various jets, as well as the jet angle design, make these floor cleaners ideal for removing sludge, mud, and other compacted materials and heavy debris (rocks, bricks, broken concrete, etc.) from storm lines, detention systems, culverts, and large sanitary lines.

KEG's unique roll cage design also ensures that our floor jet cleaner will return to its upright position to perform as designed.

KEG's Floor Cleaners feature our high-performance fluid mechanics and are Tier Three Nozzles.





The Difference Is Performance!

FLOOR CLEANER NOZZLES

Extreme power for bottom cleaning
and heavy debris removal

*Only Tier Two
Floor Cleaning Nozzle

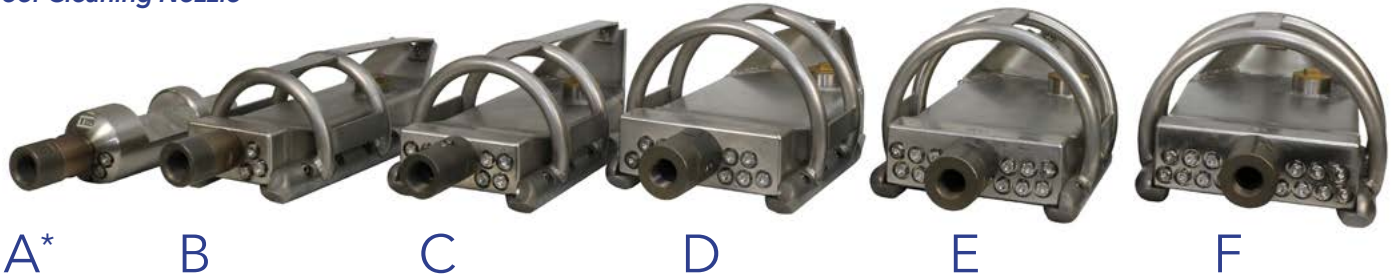

TIER THREE FLUID MECHANICS

ADVANTAGES

- Self Righting Design
- Fillable Weight Port for High Flow Conditions
- Reduced Operating Costs
- High Efficiency Cleaning
- Superior Water Pattern Design

APPLICATIONS

- **SANITARY, STORM**
- Heavy or Compacted Solids
- Removal of Sludge
- Tandem Applications (Culverts)
- High Pump Flow Applications
- Large Stone & Brick Removal



Helpful Attachment:
Angle Adaptor See
Accessories Pages

KEG FLOOR CLEANER FAMILY

Product Shown Above	Part Number	Recommended Flow Rates	Number of Inserts	Insert Size	Weight (pounds)	Dimensions	Pipe Size
A	100120	18 to 40	5	M14	18.75	10 1/4" x 3 1/2"	From 6"-18"
B	100121	30 to 60	6	M14	28.85	16" x 6 3/4"	8" to 20"
C	100122	30 to 80	8	M14	33.4	17" x 8"	10" to 36"
D	100123	50 to 80	10	M14	44.75	17" x 10"	12" to 48"
E	100124	60 to 120	12	M14	44.6	17" x 10"	15" to 60"
F	100125	From 80	14	M14	51.35	17 1/2" x 10 1/2"	18" to 72"

Please indicate "-C" for titanium ceramic inserts or "-S" for steel inserts after each part number -
All replaceable forward jet nozzles now come with an additional blank steel insert included.

Call toll free to order 1.866.595.0515

kegnozzles.com | KEGGMBH

THE FLOOR CLEANING TWINS

Efficient cleaning of big bore, heavy debris pipe

The Difference Is Performance!

"The Twins" allow the crew the ability to clean large box culverts, arch pipe, or large diameter round pipes in a more efficient manner. We achieve this by utilizing two-floor cleaners with KEG's high-performance Fluid Mechanics, working in tandem with a Y-Connector and other accessories as needed that provide the high powered flow.

"The Twins" can utilize any KEG Floor Cleaner pair depending on flow and pressure available. Units run parallel in a large diameter pipe. By using spacer bars and dual water feed lines, our twin units provide a uniform cleaning pattern over a wide diameter making this the perfect tool for larger projects.



ADVANTAGES

- Wide Water Pattern
- Dual Water Feed Capabilities
- Large Diameter Lines
- Box Culverts
- Complete Package Includes: Floor Cleaners*, Y Connector, (3) Swivels, (2) 5' Leader Hoses (2) Celvis Hooks and Spreader Bar

APPLICATIONS

- **SANITARY, STORM**
- Clears Path for Other Nozzles
- Gentle on Deteriorated Pipe
- Mud & Sand Removal

* Please see our accessories page for replaceable Y Connectors and hose options. Usage and capable information for each available accessory found on the accessories pages in the KEG Catalog.

**An extra set of inserts are included to run Floor Cleaners independently

KEG THE FLOOR CLEANER TWINS

Part Number	Description	Recommended Flow (GPM)	Number of Inserts	Insert Size	Weight (pounds)	Pipe Diameters
100121-T	(2) 6 Jet Floor Cleaners **	60+ GPM	12 Rear	M14	58	From 48"
100122-T	(2) 8 Jet Floor Cleaners **	80+ GPM	16 Rear	M14	66	From 48"
100123-T	(2) 10 Jet Floor Cleaners **	80+ GPM	20 Rear	M14	85	From 60"
100124-T	(2) 12 Jet Floor Cleaners **	120+ GPM	24 Rear	M14	85	From 72"
100125-T	(2) 14 Jet Floor Cleaners **	120+ GPM	28 Rear	M14	102	From 84"

Please indicate "-C" for titanium ceramic inserts or "-S" for steel inserts after each part number
All replaceable forward jet nozzles now come with an additional blank steel insert included.

FLOOR CLEANER HIGHRISE SKIDS

Raises floor cleaners approximately 1" off pipe bottom that allows 45° chamfer to elevate floor cleaner over offset joints up retrieval

Use with 6 Jet through 14 Jet Floor Cleaner
use with bolt-on roll cages



FLOOR CLEANER HIGHRISE SKIDS

Product Shown Above	Part Number	Floor Cleaner Usage	Weight (pounds)	Dimensions
A	100288AHL	6 Jet through 14 Jet	2.25 Each	3/4" x 2 3/4" x 12 1/2"

FINISHING NOZZLE FAMILY

*Ensuring perfectly cleaned pipe
for a streak-free inspection!*



The Difference Is Performance!



**Available in 45 or 90 degrees*

When contractors or municipalities “finish” a pipe cleaning job, they often view streaks on the pipe walls during their live feed camera inspection. These “streaks” are grease residue that has not been removed by the other cleaning processes. KEG offers our Rotor Nozzle for this purpose. The free-spinning Rotor Nozzle will remove those last grease deposits, along with tender roots and other vegetation, to “ensure perfectly cleaned pipe and a finished job,” hence our finishing label.

Rotor Nozzles run the gamut of pipe size applications, ranging from .25” to 1.25” hose threads, and 4” to 20” pipe size. The unique nozzle insert configuration provides both propulsion and rotating body action. This rotation ensures that pipes are thoroughly cleaned in all 360° of the pipe surface. Though primarily intended for grease removal, the Rotor Nozzle is equally adept at removing scaling, crusts, and small root tendrils and other tender vegetation. Maintenance requires removal of the top cap and cleaning of the rotational shaft; this can be done in a matter of minutes.

There are no bearings to oil or lubricate and no repair kits to install!

Remember, the Rotor Nozzle should be the last nozzle up the pipe before the camera inspection! KEG’s Rotor Nozzles are available with steel or titanium ceramic inserts. Our Rotors Nozzles are Tier Two Nozzles.





The Difference Is Performance!

ROTOR NOZZLE

A 360° maintenance tool that provides the finishing touch

KEG's Rotor Nozzles are an excellent tool for complete pipe cleaning when removing the remnants of grease, roots, and scale before camera inspections. It should be noted, however, that a Rotor Nozzle is NOT a cleaning nozzle and should not be used in cleaning applications.

cleaning has been accomplished. Sludge is the adhesive for the next clog to begin. KEG Rotor Nozzles are made with our unique water driven design and requires No form of lubrication for maintenance and operation. Don't use grease, oils, or other lubrication when performing maintenance on this nozzle.

Rotor Nozzles are intended to remove the grease and sludge that remain in lines after an 80 percent

KEG Rotor Nozzles are Tier Two Nozzles.

ADVANTAGES

- High Rotational Speed
- Reversible Rotating Barrel
- No Lubrication Required
- Ease of Maintenance
- Replaceable Inserts

APPLICATIONS

- **SANITARY**
- Use Before Camera Inspection
- Grease & Scale Removal
- Small Roots & Vegetation
- Manholes & Lift Stations

1" Large



1" Small



Product Shown <i>(on Next Page)</i>	Part Number	Hose Size	Number of Inserts	Insert Size	Weight (pounds)	Dimensions	Pipe Size
A	100070	1/4"	4	Factory	.25	2 1/2" x 1 1/4"	2" to 6"
B	100069	3/8"	4	Factory	.2	2 1/2" x 1 1/4"	2" to 8"
C45	100071	1/2"	7	M6	1.3	3" x 1 3/4"	3" to 10"
C90	100071-90	1/2"	7	M6	1.3	3" x 1 3/4"	3" to 10"
D	100072	3/4"	8	M8/M6	4.6	4 3/8" x 2 1/2"	4" to 12"
E	100073L	1" Large	9	M8/M6	8.45	4 3/4" x 2 3/8"	6" to 12"
E	100073	1" Small	9	M8/M6	4.4	6" x 3"	8" to 16"
F	100074	1 1/4"	9	M8/M6	8.6	5 5/8" x 3"	6" to 20"

Please indicate "-C" for titanium ceramic inserts or "-S" for steel inserts after each part number

Call toll free to order 1.866.595.0515

kegnozzles.com | KEGGMBH

SPECIALTY NOZZLE FAMILY

The perfect solution to your unique pipe cleaning applications!



The Difference Is Performance!



Your Ultimate Pipe Cleaning Solutions.

Say goodbye to the mess and complaints with KEG's innovative **Toilet Tamer Nozzle**. Designed to tackle tough cleaning tasks while being gentle on residential systems, this game-changing nozzle virtually eliminates toilet blowouts, making it the perfect choice for any residential setting. Equipped with six high-efficiency rear propulsion jets and one forward jet, the Toilet Tamer ensures exceptional cleaning and debris removal. The 30° and 40° jet angles maximize propulsion and cleaning efficiency, targeting even the most stubborn blockages. Experience unmatched performance with KEG's cutting-edge technology, delivering power and precision where it's needed most. Specially crafted to minimize disruption, this nozzle reduces or eliminates complaints from residents by preventing blowouts.

The **Equalizer Nozzle** is one of KEG's most unique nozzles, specially designed to virtually eliminate blowing toilets. Twelve forward jets at dual angles not only clean but create an umbrella pattern blocking the airflow that creates problems blowing toilets. Six powerful rearward jets with KEG's high-efficiency patented Fluid Mechanics provide the ultimate in propulsion, cleaning, and debris re-

moval. Rest assured, the Equalizer Nozzle by KEG Technologies reduces or eliminates residential complaints.

The **Aqua Power 700 Nozzle** is KEG's controlled speed rotational nozzle. By consistently running at 650 RPM, the cut can be made faster and more efficiently because of the consistent contact with the jets. The Aqua Power 700 is an excellent all-around cleaning and grease removal nozzle for pipelines, utility holes, and lift stations. The Aqua Power 700 comes with four welded skids. Additional removable skids for larger pipes are included, please note plastic or steel skids at the time of order. A high-pressure swivel with titanium ceramic inserts is also included.

The **Aqua Power Junior Nozzle** is KEG's nozzle designed for cutting applications. Its size is perfect for cutting grease and roots. The Aqua Power Junior's lightweight design makes it easier to pull up hills. Though this nozzle is compact, it works hard and can get the job done starting at 6" through 15" pipe systems.

*The perfect solution
to your unique pipe
cleaning applications!*



The **Aqua Power Mini Nozzle**, formerly the R2D2-1, is KEG's controlled speed rotational nozzle for smaller applications. The Aqua Power Mini Nozzle combines lightweight versatility and cleaning for low-flow machines running a minimum of 12GPM and operating pressure of 2000 PSI. The speed of rotation should be a consistent 650 RPM, allowing the operator to be more efficient in cutting through grease and grime within the pipe. The Aqua Power Mini Nozzle is an excellent grease removal nozzle that quickly cuts through grease while cleaning out pipes and saving time. The Aqua Power Mini Nozzle is an excellent all-around pipeline cleaning and grease removal nozzle. The Aqua Power Mini Nozzle comes with a sleeve, titanium ceramic inserts, and a leader hose (size to be specified at the time of order). Optional 4-inch and 6-inch skids are available on the accessories page for order.

The **Commander Rotor Nozzle** is designed with four forward jets that allow the nozzle to clean the pipe system upstream while removing debris downstream. This nozzle is ideal for grease and light to moderate roots. It allows the operator to clean from the top of a hill and move downstream. No lubrication is required; water moves through the nozzle, removing the heat while acting as the nozzle's lubricant.

The **Duce Nozzle** is KEG's vibrating rotational nozzle. Using the same water-driven rotation as our conventional Rotor Nozzles, the Duce Nozzle vibrates pipe deposits away. The Duce has sprocket-like front and rear end caps that use the vibrating action in the pipeline to break up hard scale and deposits. The Duce is ideal for removing grout and mortar residue, scaling, tuberculation, or other deposits that have hardened to the pipe wall or floor.

The operator should be careful to determine the overall condition of the pipe via a camera inspection before using this nozzle. Do not use the Duce Nozzle in pipes that display cracks, fissures, or other damage! The Duce Nozzle is not recommended for use in clay pipe!

The **Duce Recycler Nozzle** is purposely designed to use recycled water and a recycling truck. It is a turbo nozzle that propels the water to move the plates, rotating the nozzle barrel, which acts as a jackhammer, removing build-up and deposits along the pipe walls.

EQUALIZER NOZZLE

Virtually eliminates blowing toilets with 12 forward jets that equalize air pressure in the pipe!



The Difference Is Performance!

ADVANTAGES

- Virtually Eliminates Blowing Toilets
- Use with as Low as 50 GPM
- Custom Tuned to Your Jetting Specifications
- Replaceable Titanium Ceramic Inserts Available

APPLICATIONS

- **SANITARY, SEWER**
- Effectively Clean Problem Lines
- Save Time & Money by Reducing Residential Clean up
- Shallow Pipe Lines with Blowing/Sucking Events
- Excellent General Cleaning Nozzle

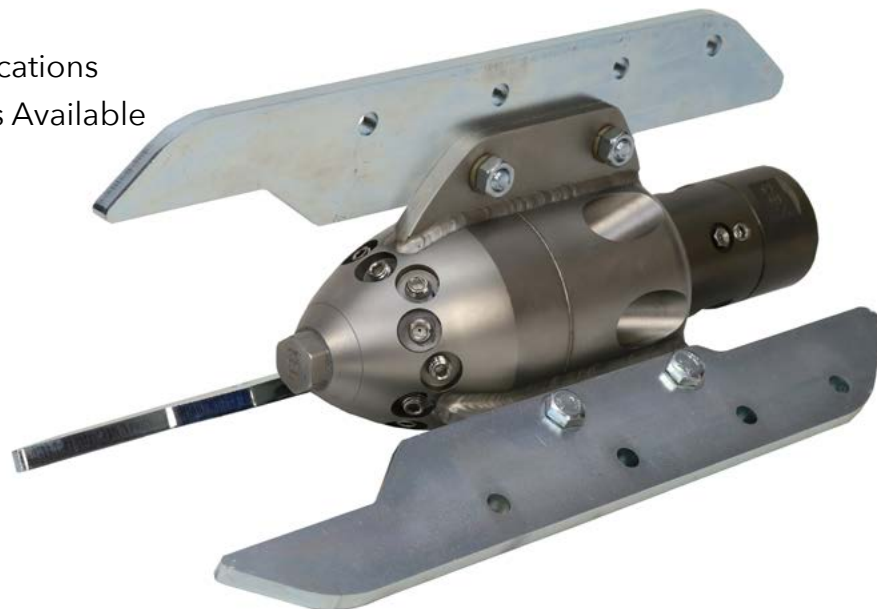

Stainless steel skids come standard with nozzle unless otherwise specified.

TECHNICAL SPECIFICATIONS

- 12 Forward Jets Reduce Vacuum Effect
- Bolt-on Skids (Included), which Increases Nozzle Body Diameter to 8" **Must Specify Plastic or Stainless Steel at Time of Order*
- Replaceable Titanium Ceramic Inserts
- High Pressure Swivel included
**Must Specify Swivel Size at Time of Order*
- Nozzle Body Made of Highly Wear-Resistant, Stainless Steel



QUICK FACTS:

- Pipe Range: 8"-24"+
- Flow Range: 50 GPM - 120 GPM
- Pressure Range: 1700 PSI - 3000 PSI
- Hose Sizes: 3/4", 1", 1 1/4"

KEG EQUALIZER NOZZLE

Product Shown Above	Part Number	Hose Size	Number of Inserts	Insert Size	Dimensions	Weight (pounds)	Pipe Size
A	100045-C	1"	12 Front 6 Back	M8 M14	6 1/2" x 4 3/4"	17.10	From 8"

TOLIET TAMER NOZZLE

Available in Aluminum
or Stainless Steel

ADVANTAGES

- Residential Friendly
- Virtually Eliminates Blowing Toilets
- Use with as Low as 50 GPM
- Custom Tuned to Your Jetting Specifications
- Replaceable Titanium Ceramic Inserts Available

APPLICATIONS

- **SANITARY, SEWER**
- Effectively Clean Problem Lines
- Save Time & Money by Reducing Residential Clean up
- Shallow Pipe Lines with Blowing/Sucking Events
- Excellent General Cleaning Nozzle



Aluminum Toliet Tamer Nozzle requires skid.

TECHNICAL SPECIFICATIONS

- 6 Propulsion Jets 1 Forward Jet
- Replaceable Titanium Ceramic Inserts
- 30° and 40° Jet Angles
- Available in Stainless Steel or Aluminum

QUICK FACTS:

- Flow Range: 50 GPM - 130 GPM
- Pressure Range: 1000 PSI - 3000 PSI

Product Shown Above	Part Number	Hose Size	Number of Inserts	Insert Size	Dimensions	Weight (pounds)	Pipe Size
A	100115WA	1"	6 Rear 1 Front	M8	4 1/4" X 2 3/4"	3.5	4" to 12"
B	100115WAA	1"	6 Rear 1 Front	M8	4 1/4" X 2 3/4"	1.5	4" to 12"

AQUA POWER 700 NOZZLE



The Difference Is Performance!

ADVANTAGES

- Multiple Applications with One Nozzle
- Cuts with Water Rather than Chain
- Controlled Rotational Speed
- Expansion Kit up to 24" Pipe Diameter (Available)
- Individual Jets for Cleaning, Propulsion, Penetration, & Rotation
- Rear Jets can be Plugged and Forward Jets Open to be Used for Manhole Cleaning*

APPLICATIONS

- **SANITARY, SEWER**
- Cleaning with Forward Jets
- Grease Removal
- Small to Medium Roots
- Hardened Deposit Removal
- Manholes and Lift Stations

TECHNICAL SPECIFICATIONS

- Controlled Speed Directional Cleaning Utilizing Centrifugal Clutches
- Main Nozzle Body will Fit in 6" Pipe
- Bolt-on Skids (included), which Increases Nozzle Body Diameter to 8"
- Versatile Penetrating Forward Jets for Cleaning, Grease Removal and Manhole Rehabilitation
- Replaceable Threaded Titanium Ceramic Inserts
- Streamlined Skids Improve Maneuverability and Decrease Snags
- Nozzle Body Made of Highly Wear-Resistant, Stainless Steel
- Swivel included .75"-1.25"

** Must specify the size of the high pressure swivel needed at time of order. 1" x 1" is the standard size

* Inserts sold separately



See accessories section for details about available expansion kits and additional inserts.

QUICK FACTS:

- Pipe Range: 8"-24"+
- Flow Range: 50 GPM - 120 GPM
- Pressure Range: 1700 PSI - 3000 PSI
- Hose Sizes: 3/4", 1", 1 1/4"



Aqua Power with Stainless Steel Skids. Other Skids Available See Skids Section for Options.



Product Shown Above	Part Number	Hose Size	Number of Inserts	Insert Size	Weight (pounds)	Dimensions	Pipe Size	
A	100276-C	3/4" - 1 1/4"	4 rear/ 6 front	M14/ M8	22.75	10" x 5 3/8"	From 8"	
B	100273-C	Expansion Kit						up to 24"



The Difference Is Performance!

AQUA POWER JUNIOR

The perfect solution to your unique pipe cleaning applications!

TIER TWO FLUID MECHANICS

The Aqua Power Junior Nozzle is KEG's nozzle designed for cutting applications. Its size is perfect for cutting grease and roots. With the Aqua Power Junior's lightweight design, it is easier to go up hills. Though this nozzle is compact, it works hard and can get the job done starting at 6" through 15" pipe systems.

ADVANTAGES

- 80+% Efficiency, Tier Two Nozzle
- Rear Jet Angles
- Rotating Jets at 90 Degrees and Two Cutting Jets at 100 Degrees
- Replaceable Inserts Available
- Controlled Rotational Speed

APPLICATIONS

- **SANITARY, STORM**
- Grease Removal
- Small Root Removal
- Scouring of Pipe Walls

TECHNICAL SPECIFICATIONS

- Controlled Speed Directional Cleaning Utilizing Centrifugal Clutches
- 6" Centering Skid Included
- Sleeve Available (See Accessories; Sold Separately)
- Replaceable Titanium Ceramic Inserts
- Nozzle Body made of Highly Wear-Resistant, Stainless Steel
- 1" Long Leader Hose Included

* Additional skids and accessories sold separately, see details on accessories pages.



Aqua Power Junior with Sleeve

QUICK FACTS:

- Pipe Range: 6" - 15"
- Flow Range: 35 GPM - 180 GPM
- Pressure Range: 1700 PSI - 3000 PSI
- Hose Sizes: 3/4" and 1"

* Additional skids and accessories sold separately, see details on accessories pages.

Product Shown Above	Part Number	Hose Size	Number of Inserts	Insert Size	Weight (pounds)	Dimensions	Pipe Size
A	100274	3/4"	4 Rear 5 Front	M6	3.25	5" x 2 1/4"	6" to 15"

Aqua Power Junior Nozzle is offered with titanium ceramic inserts only.

AQUA POWER MINI NOZZLE



The Difference Is Performance!

Formerly known as the R2D2-1 Nozzle

The Aqua Power Mini Nozzle is an excellent grease removal nozzle that quickly cuts through grease while cleaning out pipes and saving time. The Aqua Power Mini Nozzle is an excellent all-around cleaning and grease removal nozzle for pipelines.

The sleeve is included as a valuable tool when working in service laterals. The sleeve prolongs the life of the Aqua Power Mini by elevating the rotating body off the pipe as it cleans.



Aqua Power Mini Nozzle



ADVANTAGES

- Multiple Applications with One Nozzle
- Controlled Rotational speed
- Individual Jets for Cleaning, Propulsion, & Rotation
- Use Centering Skids to Prolong Nozzle Life
- Cuts with Water Rather than Chain

APPLICATIONS

- **SANITARY**
- Grease Removal
- Small Root Removal
- Scouring of Pipe Walls



Aqua Power Mini Nozzle Sleeve



Aqua Power Mini Nozzle with Sleeve



TECHNICAL SPECIFICATIONS

- Cut Down the Control of Rotation Through Cross Configuration of the Rotational Jets
- Variable Speed Controlled by the Four Rotating Jets
- Replaceable Titanium Ceramic Inserts
- Nozzle Body made of Highly Wear-Resistant, Stainless Steel
- Front Orifice is a Pressure Relief Valve
- Mini Sleeve Included

* *skids and accessories sold separately, see details on accessories page.*

QUICK FACTS:

- Pipe Range: 4"-6"+
- Flow Range: 12 GPM - 20 GPM
- Pressure Range: 1500 PSI - 2000 PSI
- Hose Sizes: 1/2"

Product Shown Above	Part Number	Hose Size	Number of Inserts	Insert Size	Weight (pounds)	Dimensions	Pipe Size
A	100270-C	1/2"	3 Rear 4 Front	M6	4.5	3 1/4" x 1 7/8"	From 4"-6"

The Aqua Power Mini Nozzle is offered with titanium ceramic inserts only

COMMANDER ROTOR NOZZLE



A

ADVANTAGES

- Replaceable Titanium Ceramic Inserts
- More Efficient Than Cutting and Milling
- This nozzle is designed to jet with the flow from the top of the hill downward.

APPLICATIONS

- **SANITARY, STORM**
- Grease
- Light Root
- Sand
- Slit

TECHNICAL SPECIFICATIONS

- Nozzle Body made of Highly Wear-Resistant, Stainless Steel
- Four rotating jets
- Four forward facing
- Four pulsion jets

QUICK FACTS:

- Pipe Range: 6"+
- Flow Range: 50 GPM - 120 GPM
- Pressure Range: 1500 PSI - 3000 PSI
- Hose Sizes: 3/4" - 1 1/4"

KEG COMMANDER ROTOR NOZZLE

Product Shown Above	Part Number	Hose Size	Number of Inserts	Insert Size	Weight (pounds)	Dimensions	Pipe Size
A	90000008RU	1"	12	M8/M6	7.25	5" x 3"	From 6"

The Commander Rotor Nozzle is offered with titanium ceramic inserts only

DUCE NOZZLE

Tight water pattern for efficient cleaning and pulling



The Difference Is Performance!

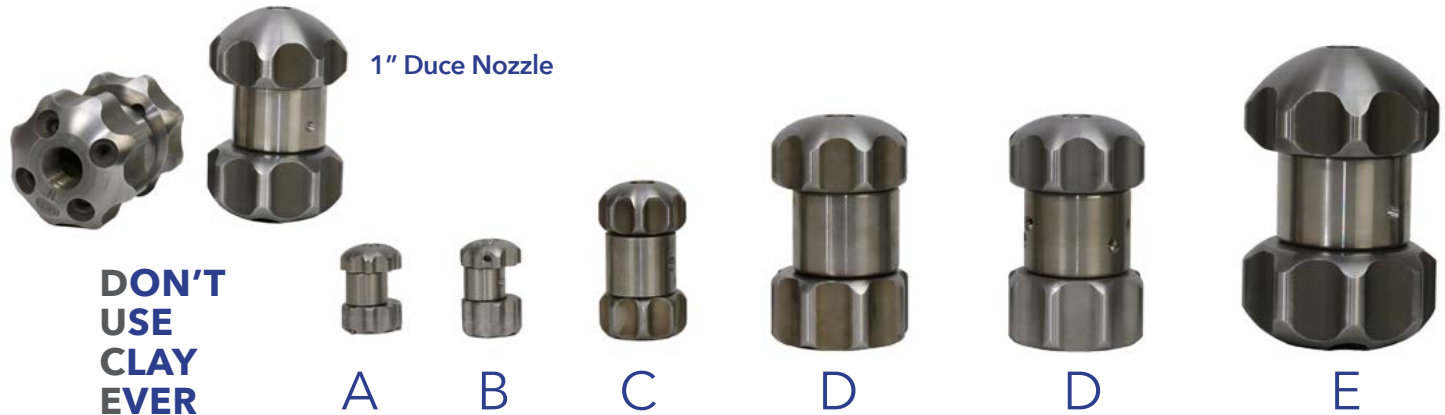

**DON'T
USE
CLAY
EVER**

1" Duce Nozzle

ADVANTAGES

- Unique Vibrating 'Jackhammer' Action
- Replaceable Titanium Ceramic Inserts Included
- Stainless Steel Inserts Only Available for .375" and .25"
- Safer than Cutting and Milling
- Less Chance of Damaging Pipes
- Designed to be Used as a Leach Aid Remover for Landfill

APPLICATIONS

- **SANITARY, STORM**
- Scale Removal
- Mineral Deposits
- Tuberculation
- Concrete and Asphalt

TECHNICAL SPECIFICATIONS

- **DO NOT USE IN CLAY PIPE**
- Nozzle Body Made of Highly Wear-Resistant, Stainless Steel

QUICK FACTS:

- Pipe Range: 2"+
- Flow Range: 5 GPM - 125 GPM
- Pressure Range: 1300 PSI - 2000 PSI
- Hose Sizes: 3/8" - 1 1/4"

Product Shown Above	Part Number	Hose Size	Number of Inserts	Insert Size	Weight (pounds)	Dimensions	Pipe Size
A	100199-S	1/4"	3 Rear 1 Rotating	M5	.4	3 3/8" x 1 7/8"	From 2"
B	100105-S	3/8"	Factory	M5	.45	1 7/8" x 1 1/4"	From 2"
B	100106	1/2"	3 Rear 3 Rotating	M8 M6	1.75	3 3/8" x 1 7/8"	From 4"
C	100107	3/4"	4 Rear 2 Rotating	M8 M6	6.5	5" x 3"	From 4"
D	101108 Duce Small	1"	4 Rear 2 Rotating	M8 M6	6.25	5" x 3"	From 4"
D	101108 Duce Large	1"	4 Rear 2 Rotating	M8 M6	14.4	6 1/2" x 4"	From 6"
E	101109	1 1/4"	4 Rear 2 Rotating	M8 M6	13.8	6 1/2" x 4"	From 6"

The Duce Nozzle is offered with titanium ceramic inserts only except for 1/4" and 3/8" nozzles as noted above.



The Difference Is Performance!

DUCE RECYCLE NOZZLE

Designed for recycled water and a recycling truck!

The Duce Recycler Nozzle is purposely designed to be used with recycled water and with a recycling truck. The Duce Recycler Nozzle is a turbo nozzle that propels the water to move the plates rotating the nozzle barrel that acts as a jackhammer removing build-up and deposits along the pipe walls.

ADVANTAGES

- Designed to Work with Recycled Water and Recycling Truck
- Replaceable Titanium Ceramic Inserts

APPLICATIONS

- **SANITARY, STORM**
- Scale Removal
- Mineral Deposits
- Tuberculation
- Concrete and Asphalt



A



1" Duce Recycle Nozzle

**DON'T
USE
CLAY
EVER**

QUICK FACTS:

- Pipe Range: 6"+
- Flow Range: 60 GPM - 125 GPM
- Pressure Range: 1300 PSI - 2000 PSI
- Hose Sizes: 1" - 1.25"

TECHNICAL SPECIFICATIONS

- **DO NOT USE IN CLAY PIPE**
- Nozzle Body Made of Highly Wear-Resistant, Stainless Steel

KEG DUCE RECYCLE NOZZLE

Product Shown Above	Part Number	Hose Size	Number of Inserts	Insert Size	Weight (pounds)	Dimensions	Pipe Size
A	100197	1"	4/1/1	M8 M14	17.8	8 1/4" x 4 1/2"	From 6"
B	100198	1 1/4"	4/1/1	M8 M14	17.8	8 1/4" x 4 1/2"	From 6"

The Duce Recycle Nozzle is offered with titanium ceramic inserts only

CHAIN CUTTER FAMILY

The only match for the toughest obstructions!



The Difference Is Performance!

KEG offers five models for customers with root infiltration, grease, concrete, protruding taps, and scaling problems. We offer the Micro Chain Cutter in 2" up to 4" applications, Mini Chain Cutter in 4" up to 10" applications, the Super Cutter Plus 150 for 6" up to 24" pipes, the Super Cutter Plus 200 up to 48", and finally the Supernova 4000 Chain Cutter up to 48" pipe, all with one cutter with expansion kits.

Let us show you the power and capabilities of our Cutter Family with a demonstration. KEG's family of chain cutters has the flexibility to handle the removal of the heaviest obstructions while being gentle on pipe walls.

*Always clean and video inspect pipe condition before operating any chain cutter and follow operating guidelines in the **cutter manual**. Contact KEG's Sales Manager for training and installation.*



SCP 150 Cutter
6"-16" up to 24"*

SCP 200 Cutter
8"-16" up to 48"*

SN 4000 Cutter
6"-16" up to 48"*

Superior Design, Construction, Performance & Flexibility

KEG's chain cutters are made of stainless steel and offer superior thrust and drive efficiency. Stabilized by stainless steel guide carriage skids, the cutters feature a unique spinner nozzle design that rotates the main shaft, spinning the attached chains at an excess of 7,500 RPM. The cross cutter bit installed on the front of the shaft also serves as a penetrating bit to "bore" into the root or obstruction. Chains can be configured for grease or scale removal, or for root removal.

* **Additional accessories required. See accessories section for available products.**

Ease of Configuration & Maintenance

The ease of field configuration is a definite plus for the operator. Installation of replacement chain, or skid configuration for larger diameters, is a simple matter and is quickly done in the field. Standard maintenance and cleaning is easy and prolongs the service life of the cutter. KEG Chain Cutters also feature a 2 year limited warranty and come configured with titanium ceramic inserts for better performance. Finally, no lubrication (other than the high pressure swivel joint at the hose connection) is required to operate a KEG Chain Cutter. Cutters can be maintained with a gentle soap or detergent and water.

Call toll free to order 1.866.595.0515

kegnozzles.com | KEGGMBH



The Difference Is Performance!

TURBO & MICRO CHAIN CUTTERS

ADVANTAGES

- Easily Configured for Multiple Jobs
- Use in Sweeping 90 Degree or 45 Degree Elbows
- Product Includes: Carrying Case, Tools and Owner's Manual
- Clean with Soap and Water

APPLICATIONS

- **SANITARY**
- 2", 3", 4" Pipes (6" w/Optional Skid)*
- Plumbing Applications
- Offsets, Pipe Rips, Services, Laterals, Small Pipes
- Root Removal in Laterals & Sanitary Service Lines
- Scale and Rust Removal
- Use with 1/2" hose*
- 5" Swivel Included

TECHNICAL SPECIFICATIONS

- No Skid Required for 2" & 3" Applications
- Individual Skid for 4" Micro Applications Included
- Individual skid for 6" Applications*
- Pump minimum of 8 GPM & 1700 PSI Required
- Tier Two Nozzle
- Titanium Ceramic Inserts Included
- Additional 5" of Chain Included
- Pulling Device Available*
- 90 Degree Lateral Applications Should Not Utilize the Guide Carriage Skids
- Reducer and Leader Hose Sold Separately



* See accessories section for available products sold separately.

QUICK FACTS:

- Pipe Range: 2" up to 6"
- Flow Range: 8 GPM+
- Pressure Range: 1700 PSI - 4000 PSI
- Hose Sizes: 3/8"-1/2"

Product Shown Above	Part Number	Hose Size	Number of Inserts	Insert Size	Weight (pounds)	Dimensions	Pipe Size
A	200110	1/2"	3 Rear/ 3 Rotating	M6	1.2	3 7/8" x 1 1/2"	2" to 6"
B	200110-T	1/2"	3 Rear/ 2 Rotating	M6	1.2	3 7/8" x 1 1/2"	2" to 6"

Titanium ceramic inserts are recommended for use with Chain Cutters

MINI CHAIN CUTTER



The Difference Is Performance!

ADVANTAGES

- Easily Configured for Multiple Jobs
- Product Includes:
Carrying Case, .Mini Chain, Cutter, ¾" HP Swivel,
Leader Hose**, and Owner's Manual
- Clean with Soap and Water

** *Must Specify Size at Time of Order

APPLICATIONS

- **SANITARY, STORM**
- 4", 6", & 8" Pipes (10" and 12" Options Available)*
- Roots, Scaling, and Grease
- Root Removal in Laterals and Sanitary Service Lines
- Removal of Protruding Taps (Clay and Plastic Pipes)
- Scale and Rust Removal

TECHNICAL SPECIFICATIONS

- Individual Skid for 4", 6" & 8" pipe
- 10" and 12" Skid Options Available*
- ¾" Swivel is the Standard Configuration
- Reducers or Expanders Available*
- Pump Minimum of 18 GPM & 1700 PSI Required
- **Tier Two Nozzle**
- Titanium Ceramic Inserts Included
- 5' of Chain Included
- ½" and 1" connection possible
with 12" leader hose optional



QUICK FACTS:

- Pipe Range: 4" - up to 12" Available
- Flow Range: 18 GPM - 60 GPM
- Pressure Range: 1700 PSI - 4000 PSI
- Hose Sizes: 1/2", 3/4", 1"

* See accessories section for available products sold separately.

KEG MINI CHAIN CUTTER

Product Shown Above	Part Number	Number of Inserts	Insert Size	Size	Weight (pounds)	Dimensions	Pipe Size
A	200343	4 Rear/ 3 Rotating	M6	1/2"	3.8	6 3/4" x 12"	4, 6, 8"
A	200344	4 Rear/ 3 Rotating	M6	3/4"	3.8	6 3/4" x 12"	4, 6, 8"
A	200345	4 Rear/ 3 Rotating	M6	1"	3.8	6 3/4" x 12"	4, 6, 8"

** Connection to 1/2" or 1" is by use of hose.



The Difference Is Performance!

SUPER CUTTER PLUS 150

TIER TWO FLUID MECHANICS

ADVANTAGES

- Stainless Steel Construction
- Water Driven Design
- High speed, High Torque
- Easily Configured for Multiple Jobs
- Roller Chain is Forgiving on Pipe Walls
- Operates in Egg-shaped Pipe
- Changeable Cross Cutter and Rotating Inserts
- Product Includes: Carrying Case, Tools and **Owner's Manual**
- Clean with Soap and Water

APPLICATIONS

- **SANITARY, STORM**
- 6"-16" Pipe Range Included
- Expansion Kit for Pipes up to 24" Available*
- Light Duty: Roots, Grease, PVC or Clay Taps, and Light Mineral
- Compatible with All Pipe Materials (PVC, Clay and Iron)
- Use with 3/4", 1", Hose

TECHNICAL SPECIFICATIONS

- Skids and Distance Plates Included for Pipes 6"-16"
- No Lubrication for the Main Body Required
- 1" HP Swivel is the Standard Configuration
- Reducers or Expanders Available*
- Two Separate Chains for Cutting
- Pump Flow Minimum of 40 GPM & 1700 PSI Required
- Tier Two Nozzle
- Titanium Ceramic Inserts Included

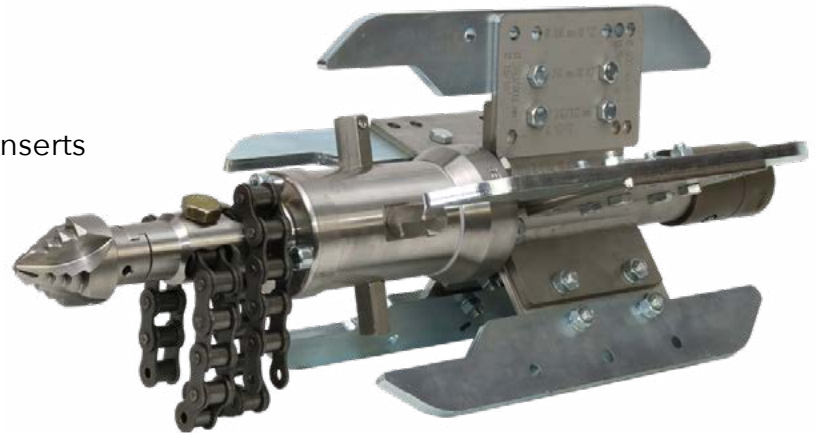

QUICK FACTS:

- Pipe Range: 16" up to 24" Available*
- Flow Range: 40 GPM - 100 GPM
- Pressure Range: 1700 PSI - 3000 PSI
- Hose Sizes: 3/4", 1"

- Additional 15' of Chain Included
- (1) Set of Hard Metal Chain Blocks for Hardened Deposits Included
- Spray Bar Attachments Available*
- Pulling Device Available*

* See accessories section for available products sold separately.

Product Shown Above	Part Number	Number of Inserts	Insert Size	Weight (pounds)	Dimensions	Pipe Size	
A	200242	4 Rotating 5 Rear	M6 M14	33.25	22 3/8" x 5"	6"-16"	
B	200903	Expansion Kit					18" - 24"

Expansion kit require purchase of all products up to needed kit size.

SUPER CUTTER PLUS 200



The Difference Is Performance!

ADVANTAGES

- Stainless Steel Construction
- High Speed, High Torque
- Roller Chain is Forgiving on Pipe Walls
- Operates in Egg-Shaped Pipe*
- Changeable Cross Cutter and Rotating Inserts
- Product Includes: Carrying Case, Tools and **Owner's Manual**
- Clean with Soap and Water

APPLICATIONS

- **SANITARY, STORM**
- 8"-20" Pipe Range
- Expansion Kit for Pipes up to 48" Available*
- Medium Duty: Roots, Grease, Minerals, Protruding Taps, Concrete
- Compatible with All Pipe Materials
- Use with 1" or 1 1/4" Hose

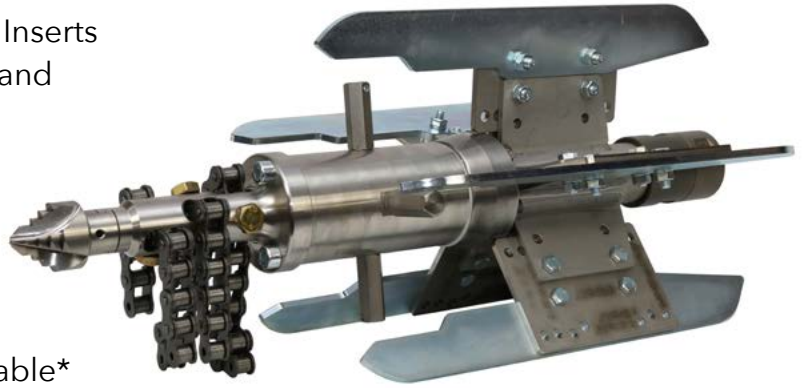

QUICK FACTS:

- Pipe Range: 8"-20" up to 48"*
- Flow Range: 60 GPM - 120 GPM
- Pressure Range: 1700 PSI - 3000 PSI
- Hose Sizes: 1" and 1 1/4"

TECHNICAL SPECIFICATIONS

- Skids and Distance Plates Included for Pipes 8"-16"
- No Lubrication for the Main Body Required
- 1" HP Swivel is the Standard Configuration
- Three Separate Chains for Cutting
- Pump Flow Minimum of 60 GPM & 1700 PSI Required
- Titanium Ceramic Inserts Included
- Additional 15' of Chain Included

- (1) Set of Hard Metal Chain Blocks for Hardened Deposits Included
- Spray Bar Attachments Available*
- Pulling Device Available and required for 32-48" Expansion

* See accessories section for available products sold separately.

Product Shown Above	Part Number	Number of Inserts	Insert Size	Weight (pounds)	Dimensions	Pipe Size
A	200151	4 Rotating 5 Rear	M6 M14	39.5	25" x 7"	8"-20"
B	Expansion Kit					up to 32"
C	Expansion Kit					up to 48"

Expansion kits require purchase of all products up to needed kit size.



The Difference Is Performance!

SUPERNOVA 4000

6" - 48" pipe all in one cutter!

TIER TWO FLUID MECHANICS

ADVANTAGES

- Stainless Steel Construction
- High Speed, High Torque Water Driven Design
- Easily Configured for Multiple Jobs
- Roller Chain is Forgiving on Pipe Walls
- Operates in Egg-Shaped Pipe*
- Product Includes: Carrying Case, Tools and **Owner's Manual**
- Clean with Soap and Water

APPLICATIONS

- **SANITARY, STORM**
- 6" - 16" Pipe Range
- Expansion Kit for Pipes up to 24" and 32" Available*
- Heavy Duty: Roots, Scaling, Rust, Grease, Minerals, All Protruding Taps
- Compatible with All Pipe Materials
- Use with 1", 1 1/4", or 1 1/2" Hose

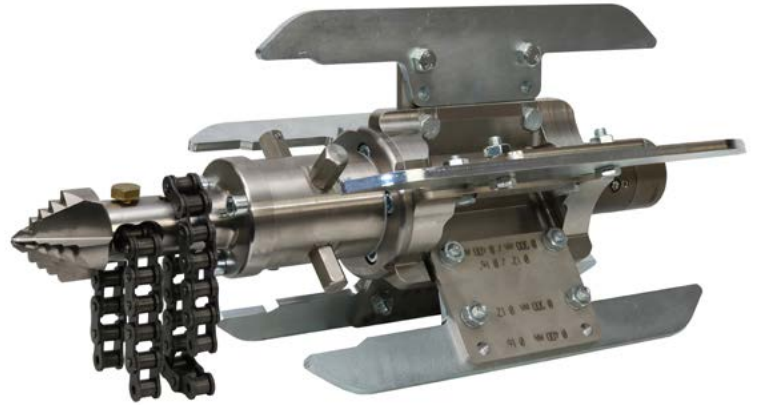

QUICK FACTS:

- Pipe Range: 6" - 16" Up to 48" Available*
- Contractor Grade Cutter
- Flow Range: 60 GPM - 150 GPM
- Pressure Range: 1700 PSI - 3000 PSI
- Hose Sizes: 1" , 1 1/4" , 1 1/2"

TECHNICAL SPECIFICATIONS

- Skids and Distance Plates Included for Pipes 6" - 16"
- No Lubrication for the Main Body Required
- 1 1/4" HP Swivel is the Standard Configuration
- Reducers or Expanders Available*
- Two Separate Chains for Cutting
- Pump Flow Minimum of 60 GPM & 1700 PSI Required
- Tier Two Nozzle
- Titanium Ceramic Inserts Included

- Additional 15' of Chain Included
- (1) Set of Hard Metal Chain Blocks for Hardened Deposits Included
- Spray Bar Attachments Available*
- Pulling Device Available and required for 32-48" Expansion kits

* See accessories section for available products sold separately.

Product Shown Above	Part Number	Number of Inserts	Insert Size	Weight (pounds)	Dimensions	Pipe Size
A	200400	8 Rotating 4 Rear	M6 M14	55.6	22" x 5 1/4"	6" - 16"
B	200402					Expansion Kit up to 24"
C	200403					Expansion Kit up to 32"
D	200404					Expansion Kit up to 48"

Expansion kits require purchase of all products up to needed kit size.

SUPERNOVA RECYCLER

6" - 48" pipe all in one cutter!



The Difference Is Performance!

ADVANTAGES

- Stainless Steel Construction
- High Speed, High Torque Water Driven Design
- Easily Configured for Multiple Jobs
- Roller Chain is Forgiving on Pipe Walls
- Operates in Egg-Shaped Pipe*
- Product Includes: Carrying Case, Tools and **Owner's Manual**
- Clean with Soap and Water

APPLICATIONS

- **SANITARY, STORM**
- 6" - 16" Pipe Range
- Expansion Kit for Pipes up to 24" and 32" Available*
- Heavy Duty: Roots, Scaling, Rust, Grease, Minerals, All Protruding Taps
- Compatible with All Pipe Materials
- Use with 1", 1 1/4", or 1 1/2" Hose

TECHNICAL SPECIFICATIONS

- Skids and Distance Plates Included for Pipes 6" - 16"
- No Lubrication for the Main Body Required
- 1 1/4" HP Swivel is the Standard Configuration
- Two Separate Chains for Cutting
- Titanium Ceramic Inserts Included
- Additional 15' of Chain Included



A

QUICK FACTS:

- Pipe Range: 6" - 16" Up to 48" Available*
- Contractor Grade Cutter
- Flow Range: 60 GPM - 150 GPM
- Pressure Range: 1700 PSI - 3000 PSI
- Hose Sizes: 1" , 1 1/4" , 1 1/2"

- (1) Set of Hard Metal Chain Blocks for Hardened Deposits Included
- Spray Bar Attachments Available*
- Pulling Device Available and required for 32-48" Expansion kits

* See accessories section for available products sold separately.

KEG SUPERNOVA RECYCLER

Product Shown Above	Part Number	Number of Inserts	Insert Size	Weight (pounds)	Dimensions	Pipe Size
A	200401	8 Rotating 4 Rear	M6 M14	55.6	22" x 5 1/4"	6" - 16"
B	200402					Expansion Kit up to 24"
C	200403					Expansion Kit up to 32"
D	200404					Expansion Kit up to 48"

Expansion kits require purchase of all products up to needed kit size.

ADJUSTABLE TURBO CUTTER

Adjustable Turbo Cutter is a high-speed medium torque chain cutter with predetermined lockable setup for metric pipe sizes 150, 200, 225, 250, 300 mm and US inch pipe sizes, 6,8,9,10, and 12 inch.



ADVANTAGES

- Stainless Steel Construction
- High Speed, Medium Torque
- Easily Configured for Multiple Jobs
- Roller Chain is Forgiving on Pipe Walls
- Changeable Cross Cutter and Rotating inserts
- Product Includes: Carrying Case, Tools and **Owner's Manual**
- Clean with Soap and Water

APPLICATIONS

- **SANITARY, STORM**
- 6"-12" Pipe Range
- Heavy Duty: Roots, Scaling, Rust, Grease, and Leachate

QUICK FACTS:

- Pipe Range: 6"-12"
- Pipe Types: PVC, Clay, Cast Iron, Ductile Iron, and Concrete.
- Flow Range: 40 GPM - 100 GPM
- Pressure Range: 1700 PSI - 3000 PSI
- Hose Sizes: 3/4" , 1"

TECHNICAL SPECIFICATIONS

- No Lubrication for the Main Body Required
- 1" HP Swivel is the Standard Configuration
- Two Separate Chains for Cutting
- Pump flow minimum of 40 GPM and 1700 PSI required
- Titanium Ceramic Inserts Included
- Additional 15' of Chain Included
- (1) Set of Hard Metal Chain Blocks for Hardened Deposits Included

** See accessories section for available products sold separately.*

KEG ADJUSTABLE TURBO CUTTER

Product Shown Above	Part Number	Number of Inserts	Insert Size	Weight (pounds)	Dimensions	Pipe Size
A	209600	4 Rotating 4 Rear	M6 M14	39.5	25" x 7"	6"-12"

EJECTOR NOZZLE FAMILY

Soft cleaning for fully charged, large sewer pipes!



The Difference Is Performance!

Ejector Nozzles are suitable for cleaning water-bearing pipes only. The unique arrangement of the nozzle inserts results in the "soft" cleaning effect, which makes the Ejector Nozzles suitable for

cleaning older sewer networks. This nozzle uses the water flowing within the sewer to aid the water coming from the pressurized hose, thus utilizing the advantages of both cleaning methods.

Ejector Nozzle (Small)



APPLICATIONS

- **SANITARY, STORM**
- Slit, Sand and Rock

TECHNICAL SPECIFICATIONS

- For Pipes From 15" and Up
- Comes with (1) 1" HP Swivel
- Comes with Ceramic Inserts
- Includes:
Y Connector,
1" x 3' leader hoses

KEG EJECTOR NOZZLE

Product Shown Above	Part Number	Hose Size	Number of Inserts	Insert Size	Weight (pounds)	Dimensions	Pipe Size
A	0080199	1"	6	M8	22.25	12 5/8" x 7 7/8" x 7 7/8"	From 10"
B	0080200	1"	6	M8	29.25	16 1/2" x 10 3/8" x 8 3/4"	From 16"

HYDRO-X EXCAVATION NOZZLE FAMILY

The only match for the toughest obstructions!

Hydro Excavation Nozzles are often a more precise and safer way of digging than with traditional mechanical means. KEG offers nozzles for these applications with either stationary or oscillating digging jets, depending on your needs. Our Hydro Excavation Nozzles; Hand Injector Nozzle, Twister Nozzle, and Triple Edge Quattro are all suited for 1/2" hose connections, with the Twister Nozzle offering multiple connection sizes.

- The **Hydro-X Hand Injector Nozzle's** single jet cuts through roots faster because of the water pressure through the jetted nozzle.
- The **Hydro-x Twister Nozzle's** unique oscillating excavation jet allows the operator to use in all digging environments, such as piping systems, ground utilities, and hoses.
- The **Hydro-X Triple Edge Quattro Nozzle's** unique design of four forward jets provides the perfect angles to cut through debris, allowing the operator to work within a small space.



HYDRO-X HAND INJECTOR NOZZLE

Excellent for Manual Cleaning

The Hydro-X Hand Injector Nozzle provides the capability of water flow up to 25 GPM and up to 4000 PSI. Hand Injector's single jet cuts through roots faster because of the water pressure through the jetted nozzle.

ADVANTAGES

- Precise Single Jet
- Root Cutting
- Stainless Steel Body

APPLICATIONS

- Designed for Large Root Removal
- Digging Outside of Pipe/Gas Lines
- Pipe Location
- Congested Areas

TECHNICAL SPECIFICATIONS

- All-terrain Usage
- Excellent for Hydro Excavating & Manual Cleaning
- Flow Ranges from 4 GPM - 25 GPM
- Comes with (1) Replaceable Titanium Ceramic Insert
- Not Used for Cleaning Sewer Lines



KEG HYDRO HAND INJECTOR NOZZLE

Product Shown Above	Part Number	Hose Size	Number of Inserts	Insert Size	Weight (pounds)	Dimensions
A	100136	1/2"	1 Front	M14	.55	3 1/4" x 1"

HYDRO-X TRIPLE EDGE QUATTRO NOZZLE

Reliable obstruction removal with forward jets and sharp edge design

The Hydro-X Triple Edge Quattro Nozzle is an excellent penetrating nozzle used for excavation, root systems removal, and dirt extraction in tight spaces. This nozzle's unique design of four forward jets provides the perfect angles to cut through debris, allowing the operator to work within a small space.



ADVANTAGES

- Sharp Chiseled Edges
- Root Cutting

APPLICATIONS

- Designed to Dig
- Removal of Dirt, Debris and Root Systems Within Tight Spaces
- Digging Outside of Pipe/Gas Lines
- Pipe Location
- Congested Areas

TECHNICAL SPECIFICATIONS

- All-terrain Usage
- Comes with (4) Replaceable Titanium Ceramic Inserts
- Flow ranges from 6 GPM to 25 GPM
- Nozzle Body Made of Highly Wear-Resistant, Stainless Steel

KEG HYDRO TRIPLE EDGE QUATTRO NOZZLE

Product Shown Above	Part Number	Hose Size	Number of Inserts	Weight (pounds)	Dimensions	Pipe Size
A	100054-HX	1/2"	4 Forward	.3	2 1/4" x 1"	From 3"

HYDRO-X TWISTER NOZZLE



The Difference Is Performance!

Oscillating forward jets are excellent for hydro excavation and cleaning lines

The Hydro-X Twister Nozzle can dig safer within tight spaces without damaging underground resources. This unique oscillating excavation jet allows the operator to use in all digging environments, such as piping systems, ground utilities, and hoses.

ADVANTAGES

- Oscillating Front Jet Cleans and Penetrates
- Safe for Digging Around All Types of Pipes

APPLICATIONS

- Excellent for Hydro Excavating
- Removal of dirt, debris and root systems within tight spaces
- Digging alongside of Pipe, Gas Lines and underground utilities
- Congested Areas

TECHNICAL SPECIFICATIONS

- All-terrain Usage
- Rebuild Kit Available (Sold Separately)
- Comes With a 1 Year Factory Warranty
- Flow Ranges from 8 GPM to 20 GPM
- Nozzle Body Made of Highly Wear-Resistant, Stainless Steel



A

Product Shown Above	Part Number	Hose Size	Weight (pounds)	Dimensions
A	101320-HX	1/2"	.7	2 1/2" x 1 1/2"
B	101321-HX	3/4"	1	2 5/8" x 1 5/8"
C	101322-HX	1"	1.7	4" x 2"



The Difference Is Performance!

CUSTOM NOZZLE KITS

Buy more and save!

KEG offers many kit combinations and arrangements. The kits are intended to give the customer options and are customized to fit specific needs and job requirements. Our kits consist of four to six nozzles of the same size with a custom fitted carrying case. Below are some of the most popular nozzle kit combinations listed by size and part number.



POPULAR 1" CUSTOM KITS

1" COMPLETE KIT

- 1" Rambo
 - 1" Royal
 - 1" Rotor
 - 1" Traction
 - 1" Torpedo
 - 1" Cleaning
- part #: KIT-1"-COM

1" STORM KIT

- 1" Rambo
 - 1" Royal
 - 1" Traction
 - 1" Torpedo
 - 1" Sewer
- part #: KIT-1"-STRM

1" BASIC KIT

- 1" Rambo
 - 1" Cleaning
 - 1" Traction
 - 1" Torpedo
- part #: KIT-1"-BASC

1" SANITARY KIT

- 1" Rambo
 - 1" Cleaning
 - 1" Traction
 - 1" Torpedo
 - 1" Rotor
- part #: KIT-1"-SAN

** The Sanitary Kit is also available in 3/4" and 1/2".*

1" STARTER KIT: TIER THREE

- 1" Cleaning
 - 1" Traction
 - 1" TEQ
- part #: KIT-1"-STARTER

** The Starter Kit is also available in 3/4" and 1/2".*

CREATE YOUR OWN

- Customize Your Kit Today
- Custom Kits ONLY Available for the Same Size Machine
- Kits Have a Minimum of 4 and up to 6 Nozzles
- See Specification Page for Details on Each Nozzle Available

**Kits must include case to received special kit pricing
Interested in a custom kit, but do not see it? Give our office a call.*



CUSTOM NOZZLE KITS

Buy more and save!



The Difference Is Performance!

KEG offers many kit combinations and arrangements. The kits are intended to give the customer options and are customized to fit specific needs and job requirements. Our kits consist of up to 13 nozzles of the same size with a custom fitted carrying case. Below are some of the most popular nozzle kit combinations listed by size and part number.

POPULAR 3/4" and 1/2" CUSTOM KITS

3/4" STORM KIT

- 3/4" Rambo
- 3/4" Royal
- 3/4" Traction
- 3/4" Torpedo
- 3/4" Sewer
- 8 Jet Floor Cleaner
part #: KIT-3/4"-STRM

1/2" STARTER KIT: TIER THREE

- 1/2" Cleaning
- 1/2" Traction
- 1/2" Triple Edge Quarttro
part #: KIT-1/2"-BASC-3

1/2" BASIC KIT: TIER TWO

- 1/2" Egg
- 1/2" Sewer Flush
- 1/2" Triple Edge Quarttro
part #: KIT-1/2"-BASC-2

1/2" 13-PIECE KIT

- 1/2" Rambo
- 1/2" Cleaning
- 1/2" Rotor
- 1/2" Traction
- 1/2" Egg Devastator
- 1/2" Forward Jet
- 1/2" Standard
- 1/2" Sewer Flush
- 1/2" Ball
- 1/2" Micro Chain Cutter
part #: KIT-1/2"-13PCE

1/2" COMPLETE KIT

- 1/2" Rambo
- 1/2" Egg Devastator
- 1/2" Rotor
- 1/2" Traction
- 1/2" Forward Jet
- 1/2" Cleaning
part #: KIT-1/2"-COMP

1/2" GREASE KIT

- 1/2" Cleaning
- 1/2" Traction
- 1/2" Triple Edge Quarttro
- 1/2" Rotor
- 1/2" Forward Jet
part #: KIT-1/2"-GRSE



CREATE YOUR OWN

- Customize Your Kit Today
- Custom Kits ONLY Available for the Same Size Machine
- Kits Could Include 4 to 6 Nozzles
- See Specification Page for Details on Each Nozzle Available

**Kits must include case to received special kit pricing
Interested in a custom kit, but do not see it? Give our office a call.*



The Difference Is Performance!

KLEEN SIGHT 3.0 CAMERA NOZZLE

Clean and video record simultaneously!

Our Kleen Sight Camera Nozzle allows the user to identify problems quickly, collapsed line, protruding laterals, deteriorating pipe, blockages, and more. Our nozzle not only records within the piping system it also cleans 360 degrees while recording.

The rugged stainless steel construction, waterproof magnetic function switch, protects the camera from moisture damage and also allows for a user-friendly experience. Kleen Sight Camera has many features that make using this nozzle your go-to choice when troubleshooting and cleaning pipe systems.



Before cleaning video view

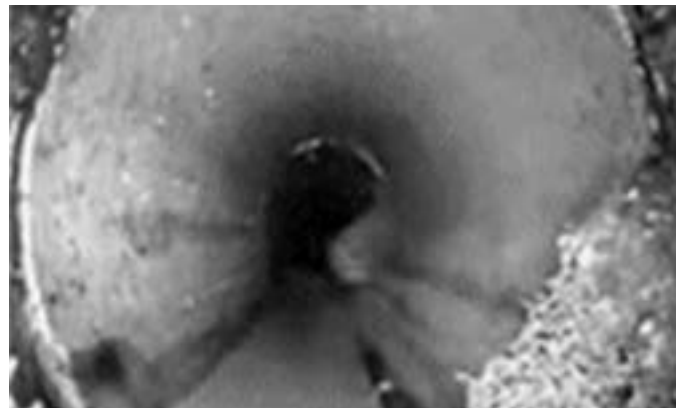
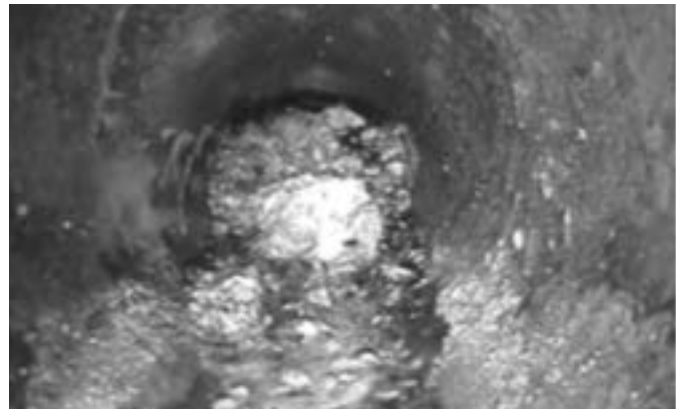

After cleaning video view

DETAILED FEATURES

- Red LED indicate various camera mode
- Wi-Fi hotspot
- Energy consumption in Wi-Fi mode just under 30% of recording mode
- Multiple device access is possible
- Files are automatically date and time stamped and convert to MP4
- Video files can be viewed instantly without downloading depending on your device and video player
- Video Format/Info: Advanced Video Codec
- Codec ID: H264

Expansion kits available see accessories.

KLEEN SIGHT 3.0 CAMERA NOZZLE

Get a better look inside your pipe system!

This nozzle is adaptable for larger pipe systems with removable steel skids. Please see the accessories pages for details.

Watch and download video footage via Wi-Fi on your smartphone, tablet, or laptop! No cords or cables needed! Connects to your Jetter hose!



Expansion kits available see accessories.

FEATURES

- High Definition Self Leveling Camera Head
- Internal Memory
- Wi-Fi Hot Spot to Directly Download Data
- No Need to Pre-Clean Lines Before Use
- 6 high powered LED Lights
- 6+ Hours of Video Per Charge
- Waterproof Magnetic Function Switch
- Built In Li-Ion Battery and 110 VAC Charger
- Replaceable Titanium Ceramic Inserts
- Skids included for Pipe 6" to 16"

ADVANTAGES

- HD Video Recording and Camera Captures High Resolution Quality Images
- No SD Card Needed
- No Exposed Components
- Saves Time and Money
- Illumination for All Visual Needs; No Smoke or Fog
- Full Day Video Capability
- Protects From Moisture
- 15 & 25 Degree Jets
- 5 Year Warranty on Inserts
- 1 Year Warranty; Kleen Sight Camera Nozzle
- Expansion Kits Available* - Up to 24"

* Accessories sold separately

Product Shown Above	Part Number	Number of Inserts	Insert Size	Weight (pounds)	Dimensions	Pipe Size	
A	701002-3	8	M14	26	15 3/4" x 4 3/4"	6" - 16" +	
B	7000008-C	Expansion Kit					up to 24"



The Difference Is Performance!

EXPANSION KIT

Expansion kits are necessary when cleaning larger pipe systems. We offer expansion kits that attach to a variety of nozzles to meet your cleaning needs.

If you have questions, contact your sales representative or call our office for answers. We are here to provide the tools needed to get the job done, right!



SUPER NOVA 24"

part #: 200402-C

SUPER NOVA 32"

part #: 200403-C

SUPER NOVA 48"

part #: 200403-C

AQUA POWER 700

part #: 100273-C

CAMERA 24"

part #: 700008-C

Individual nozzles are available in the Keg Technologies catalog. Specific nozzles and additional materials are needed to achieve the desired expansion size. If you have any questions about the expansion kits and the necessary materials, please don't hesitate to contact our office or your Keg Technologies territory manager.

KEG EXPANSION KITS

Expansion Kits	Part Number	Hose Size	Dimensions	Pipe Size
Aqua Power 700	100273-C	1"	24"	Up to 24"
Super Nova - 24"	200402-C	1"	24"	Up to 24"
Super Nova - 32"	200403-C	1"	32"	Up to 32"
Super Nova - 48"	200404-C	1"	48"	Up to 48"
Camera - 24"	700008-C	1"	24"	Up to 24"

Expansion kits require purchase of all products up to needed kit size.

EXPANSION KITS



The Difference Is Performance!

Expansion kits are additional products that attach to a nozzle for larger pipe applications. Each piping system needs are different in size, tools, and solutions. We have the means to achieve the solution you need!

Take a look at our expansion kit options below for your piping needs. If you have questions, contact your sales representative or call our office for answers. We are here to provide the tools needed to get the job done, right!



CHAIN CUTTER 150

part #: 200903-C

CHAIN CUTTER 200 32"

part #: 200901-C

CHAIN CUTTER 200 48"

part #: 200902-C

KEG EXPANSION KITS

Expansion Kits	Part Number	Hose Size	Dimensions	Pipe Size
Chain Cutters 150 - 24"	200903-C	1"	24"	Up to 24"
Chain Cutters 200 - 32"	200901-C	1"	32"	Up to 32"
Chain Cutters 200 - 48"*	200902-C	1"	48"	Up to 48"

*Expansion kits 24" and 32" required to achieve the 48" expansion kit.

ACCESSORIES



The Difference Is Performance!

REPLACEABLE INSERTS

The purpose of the inserts gives the ability to dial in the nozzle to the specific flow rate, and pressure rating needs to complete any jetting task.



ADVANTAGES

- **Titanium Ceramic:**
5 Year Warranty Best Performance (Jet Pattern)
- Increased Warranty (3 Years) on Nozzle ONLY with Usage of Titanium Ceramic Inserts
- **Steel Allen Head:** Older Design
- Interchangeable with Hex Head (M8) Only
- **Steel Hex Head:** Newer Design
- **Stainless Steel:** 1 Year Warranty

Part Number	Insert Size	Material
G00100130	M14	Stainless Steel Hex
G00100174	M14	Titanium Ceramic - Hex Head
G00100135	M8	Stainless Steel- Hex Head
G00100138A	M8	Stainless Steel
G00100173	M8	Titanium Ceramic - Hex Head
G00100177A	M8	Titanium Ceramic
G00100134A	M6	Stainless Steel
G00100175A	M6	Titanium Ceramic

INSERT HOLDERS

This handy product allows the user to place the insert holder in the orifice and add a small insert when the original sized insert is not available. This product acts as an insert sleeve allowing for the use of a smaller insert to be placed within the holder for nozzle usage.

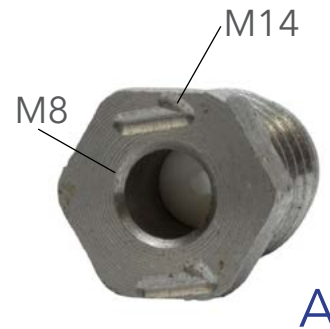

Product Shown Above	Part Number	Holder Size	Insert Size	Weight (pounds)	Dimensions	Material
A	G00100153	M14	M8	.1	5/8" Diameter	Stainless Steel

ACCESSORIES

REPLACEABLE RAMBO TIPS



The Difference Is Performance!

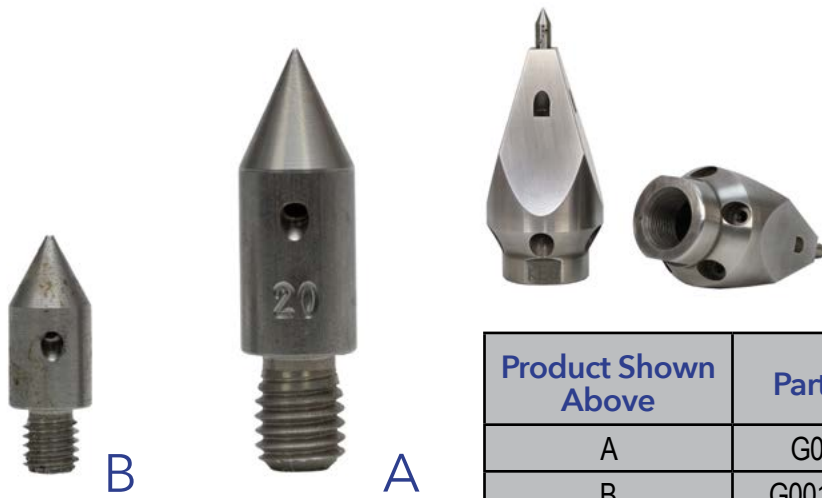

KEG REPLACEABLE RAMBO TIPS

Product Shown Above	Part Number	Inserts Size	Material
A	G001000062	M8	Stainless Steel
B	G001000062-M5	M5	Stainless Steel

HIGH PRESSURE SWIVELS



Product Shown Above	Part Number	Connection Size
A	G00800010	1/2" x 1/2"
B	G00800011	3/4" x 3/4"
C	G00803412	3/4" x 1/2"
D	G00801012	1" x 1/2"
D	G00801034	1" x 3/4"

Product Shown Above	Part Number	Connection Size
D	G00800012	1" x 1"
E	G00801141	1 1/4" x 1"
E	G00800014	1 1/2" x 1 1/2"
F	G00800013	1 1/4" x 1 1/4"

ACCESSORIES



The Difference Is Performance!

CUTTER SKIDS

Plastic skids are designed to make the chain cutter lighter; creates less drag and protects the lining of the ductile iron lining and PVC piping, which will not scratch piping. These plastic skids also protect the pipe lining from breaking during cleaning vibration.

Stainless steel skids are the standard application of all chain cutters and are a durable option to handle heavy-duty tasks.

Chain cutter skids must be used for the correct size pipe, or else it will void the warranty of the nozzle.

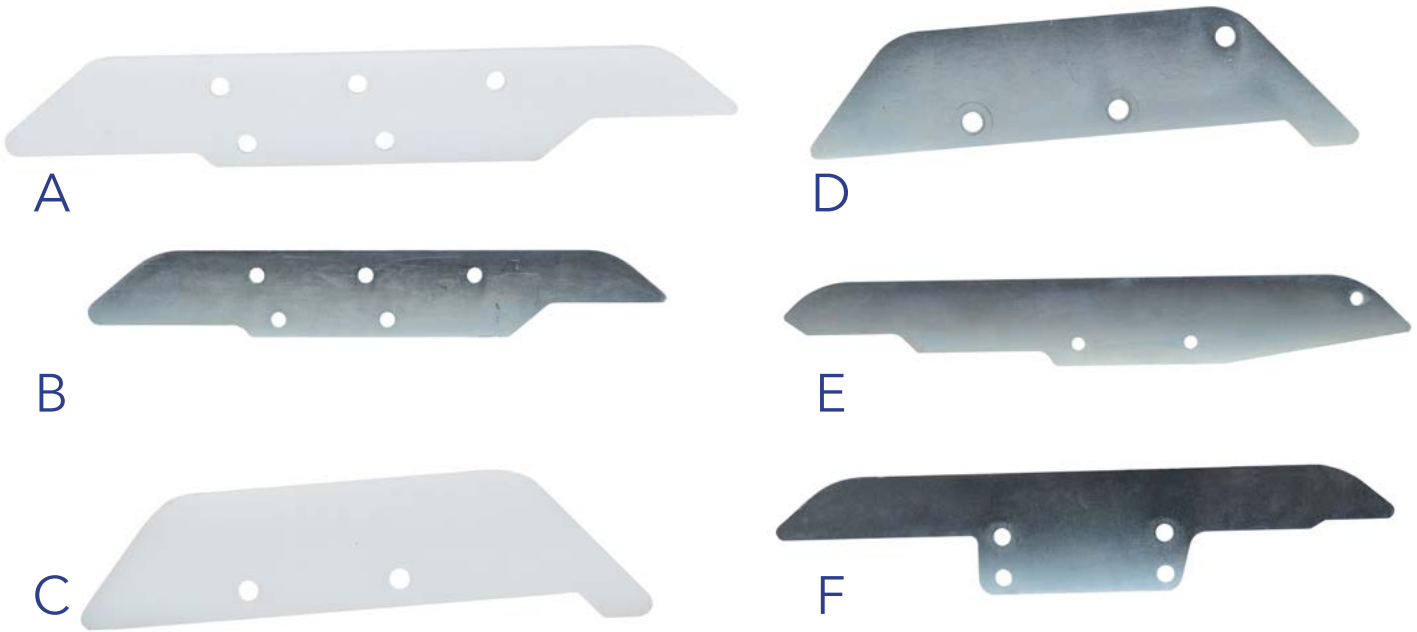

CUTTER SKIDS

Product Shown Above	Part Number	Nozzle Usage	Weight (pounds)	Dimensions	Pipe Size
A	100287P	Super Cutter Plus 150 Equalizer	.25	9" x 2 1/2"	From 6"
B	210045	Super Cutter Plus 150 Equalizer AP 700	1.65	12 1/2" x 2"	6"-16"
C	210045P	Aqua Power 700"	.3	12 1/2" x 2"	6"-16"
D	100287	Aqua Power 700	1.2	9" x 2 1/2"	From 6"
E	210010	Super Cutter Plus 200	1.7	15 1/2" x 2 1/4"	8"-20"
F	200414	Super Nova 4000	2.35	15" x 3"	6"-16"

"P" in part number indicates plastic skids.

GUIDED CUTTER SKIDS

Tight water pattern for efficient cleaning and pulling

The unique, Guide Skid is designed for use with the Micro Chain Cutter, Mini Chain Cutter, Aqua Power Junior and Aqua Power Mini. The Guide Skid allows the nozzle to rest within the skid, which

provides the nozzle to remain centered within the pipe, optimizing the water flow, cutting through pipe debris.

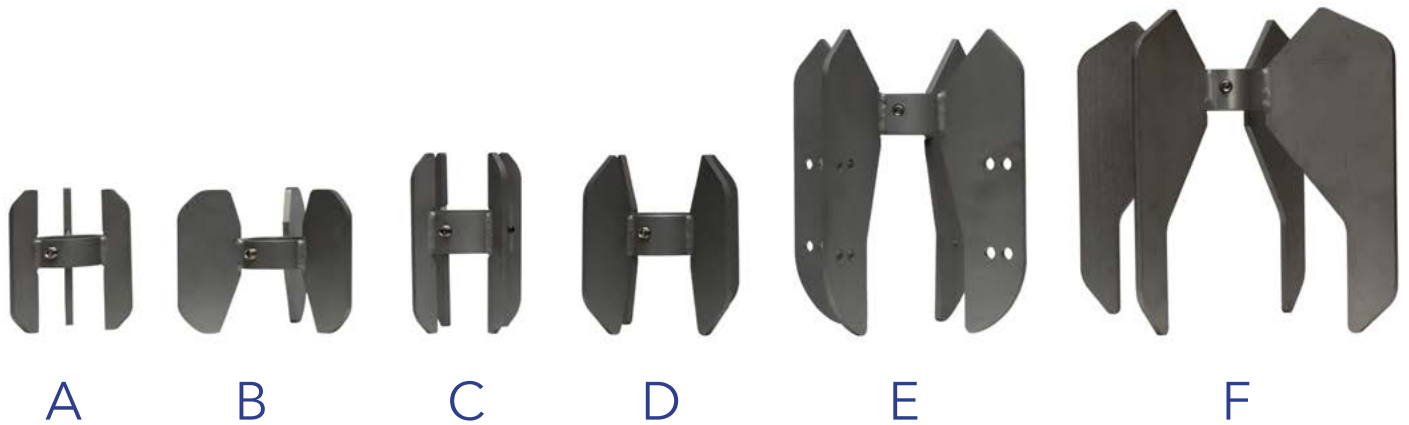

GUIDED CUTTERS SKIDS

Product Shown Above	Part Number	Nozzle Usage	Weight (pounds)	Dimensions	Pipe Size
A	200111	Micro Cutter 4" Aqua Power Mini	.75	3 1/4"	4"
B	200112	Micro Cutter 6" Aqua Power Mini	1.25	5 1/4"	6"
C	200065	Mini Cutter 4" Aqua Power Junior	1.2	2 3/4"	4"
D	200067	Mini Cutter 6" Aqua Power Junior	1.85	4 1/4"	6"
E	200068	Mini Cutter 8" Aqua Power Junior	3.8	5 1/4"	8"
F	200068B	Mini Cutter 10" Aqua Power Junior	4.55	6 3/4"	10"

THUMBNAIL SKIDS AND HOLDERS

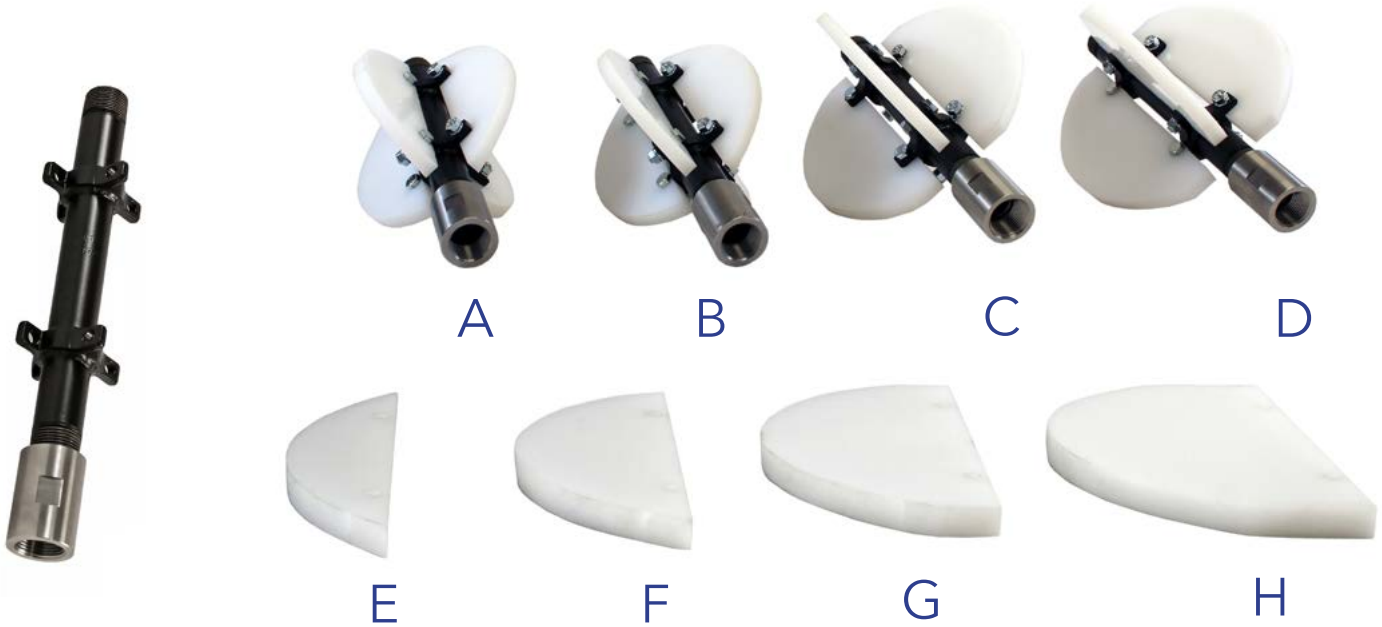

SKID HOLDERS

Part Number	Hose Size	Usage	Hose Size	Skids
STNPIPE3-3/4	3/4"	PIPE HOLDER FOR 3 SKIDS	3/4"	3
STNPIPE4-3/4	3/4"	PIPE HOLDER FOR 4 SKIDS	3/4"	4
STNPIPE3-1	1"	PIPE HOLDER FOR 3 SKIDS	1"	3
STNPIPE4-1	1"	PIPE HOLDER FOR 4 SKIDS	1"	4

SKID SETS

A	STNPIPE3-6	6" THUMBNAIL SKID	3
B	STNPIPE3-8	8" THUMBNAIL SKID	3
C	STNPIPE3-10	10" THUMBNAIL SKID	3
D	STNPIPE3-12	12" THUMBNAIL SKID	3
A	STNPIPE4-6	6" THUMBNAIL SKID	4
B	STNPIPE4-8	8" THUMBNAIL SKID	4
C	STNPIPE4-10	10" THUMBNAIL SKID	4
D	STNPIPE4 -12	12" THUMBNAIL SKID	4

INDIVIDUAL THUMB NAILS

E	STNPIPE1-6	6" THUMBNAIL SKID
F	STNPIPE1-8	8" THUMBNAIL SKID
G	STNPIPE1-10	10" THUMBNAIL SKID
H	STNPIPE1-12	12" THUMBNAIL SKID

Skid Sets (Thumbnail skids are interchangeable with 3/4" or 1" holders.)

SKIDS WITH HOLES



The Difference Is Performance!

Skids are required for use on the Aluminum Traction, Cleaning, Torpedo, and Royal Nozzles, or the nozzle warranties will be voided. The aluminum skids with holes have a drag consistency, which is lighter, making it more maneuverable and easier to operate. Aluminum skids with holes use less flow and less pressure.

Steel skids are heavier, which outlast its lighter aluminum counterpart. It is also essential to match

the number of jets and the number of wire for skid usage that allows for individual water tracks for each water line.

The purpose of the skids with holes is to balance the nozzle inside the pipe preventing the nozzle from becoming airborne and coming out the manhole. This an additional safety feature providing additional holes allows the user to secure the nozzle on the skid while inside the pipe.



Aluminium 3/4" skids



Aluminium 1" skids

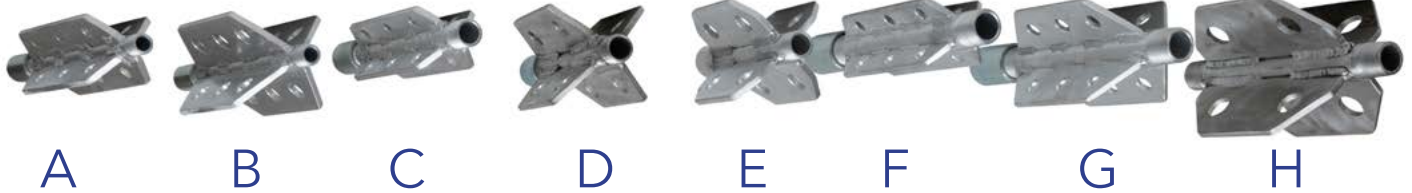

KEG SKIDS WITH HOLES

Product Shown Above	Part Number	Hose Size	Weight (pounds)	Dimensions	Material	Product
A	FE-41ALHD-5	.38"	1.45	12" x 4"	HD Alum	Holes
B	FE-61ALHD-5	1/2"	1.7	12" x 6"	HD Alum	Holes
C	FE-41ALHD-75	3/4"	1.45	12" x 4"	HD Alum	Holes
D	FE-61ALHD-75	1"	1.95	12" x 6"	HD Alum	Holes
D	FE-61ALHD8	3/4"	1.25	8" x 6"	HD Alum	Holes
E	FE-41ALHD-1	1"	2.1	12" x 4"	HD Alum	Holes
E	FE-61ALHD-1	1"	2.5	12" x 6"	HD Alum	Holes
F	FE-41-4WH-75	3/4"	3.6	12" x 4"	Stainless Steel	Holes
G	FE-41-4WH-1	1"	3.78	12" x 4"	Stainless Steel	Holes
H	FE-61-4WH-1	1"	5.9	13 3/4" x 6"	Stainless Steel	Holes

KEG's recommends using a entering device with our Aluminium line of nozzles to ensure maximum performance and protect from premature wear. Our standard warranty ONLY applies to aluminium nozzles when used with a skid.

ACCESSORIES



The Difference Is Performance!

LEADER HOSE

KEG Accessories are a must have for tough jobs!

Operating Pressures from 2500 PSI to 4000 PSI. Can be ordered with male/male or male/female swivel ends.

KEG LEADER HOSES



1/2" x 20' Hose



1/2" x 10' Hose

Part Number	Hose Size	Length
LH0810	1/2"	10'
LH0815	1/2"	15'
LH0820	1/2"	20'
LH0825	1/2"	25'
LH1210	3/4"	10'
LH1215	3/4"	15'
LH1220	3/4"	20'
LH1225	3/4"	25'
LH1610	1"	10'
LH1615	1"	15'
LH1620	1"	20'
LH1625	1"	25'

Part Number	Hose Size	Dimensions
A00900016	1/2"	1/2" x 1'
A00900017	1/2"	3/4" x 1'
A00900017A	3/4"	3/4" x 1'
A00900018	3/4"	1" x 1'
A00900018A	1"	1" x 1'



2 1/4" Tyger Tail



3 1/4" Tyger Tail



TYGER TAILS

3" x 36" heavy duty hose protector with rope protects against cuts, and scrapes and prolongs hose life.

Part Number	Hose Size	Length
700-D090	2 1/4"	3'
700-D089	3 1/4"	3'

ACCESSORIES

REDUCING BUSHINGS & STEP UP EXPANDERS



The Difference Is Performance!

REDUCING BUSHINGS

Part Number	Bushing Type	Size
A00800026	Reducer	3/8" x 1/4"
A00800025	Reducer	1/2" x 3/8"
A00800020	Reducer	3/4" x 1/2"
A00800028	Reducer	3/4" x 5/8"
A00800021	Reducer	1" x 3/4"
A00800022	Reducer	1 1/4" x 1"
A00800029	Reducer	1 1/2" x 1 1/4"



Our bushings can expand or reduce the flow of water to accommodate the hose size as the project requires.

We offer an array of bushing or expanders from 3/8" - 5/8" to 1" - 1 1/4."

STEP UP EXPANDERS

Part Number	Bushing Type	Size
A00800027	Expander HP	1/2" x 3/4"
A00800024	Expander	3/4" x 1"
A00800023	Expander	1" x 1 1/4"



Aqua Power Junior and Aqua Power Mini Sleeves are best used when performing service laterals and in pipes with tight bends. Using the sleeve takes the

AQUA SLEEVES

place of a skid. The sleeve is designed to keep the nozzle out of the dirt and allows the nozzle to perform in tight places optimally.

Product Shown Above	Part Number	Weight (pounds)	Dimensions
A	G00100279	.55	2 3/8" x 1 7/8"
B	G00100280	1.75	3 1/2" x 2"

ACCESSORIES

KEG's Anti Hook Device keeps nozzles from getting caught within a pipe. This valuable tool attaches to the nozzle on the skids, which acts as a rail system to retrieve the nozzle without getting caught within the pipe or piping system.

The Anti Hook Device can be used with cutters and any nozzles that use skids and can be adapted to fit.

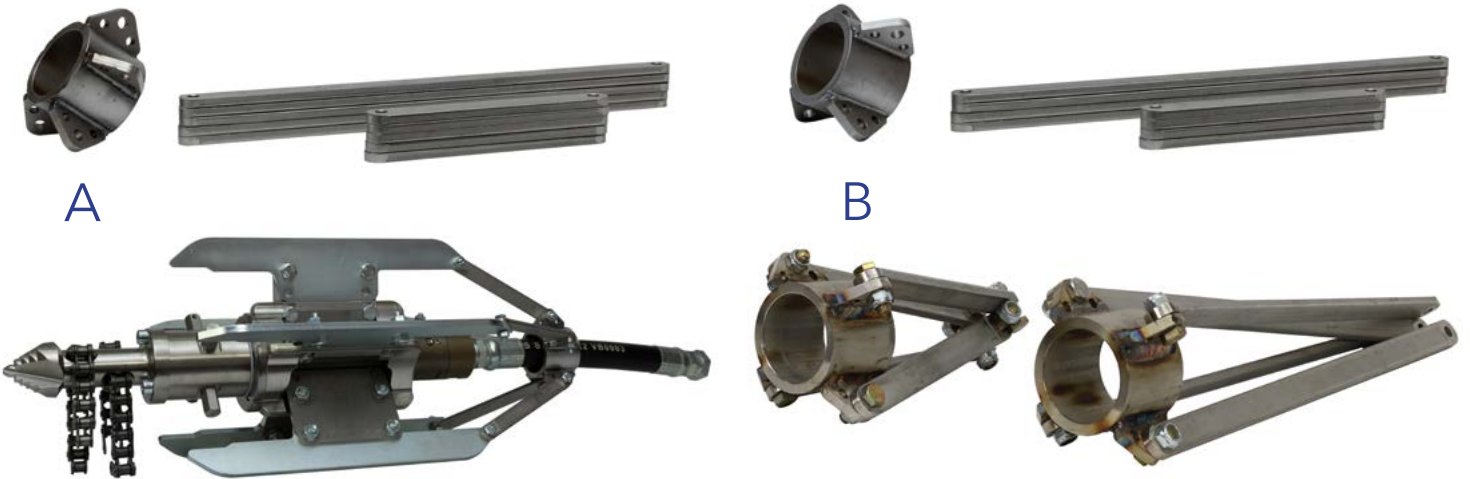

Product Shown Above	Part Number	Weight (pounds)
A	80004	2.6
B	80005	5.05

FIRE HOSE NOZZLE

It is a stainless steel nozzle designed with a handle assists in washing down the maintenance hole, debris tank, the truck, and even used in lift stations to blast grease from walls and pumps.

Comes with deadman valve for additional safety.



Product Shown Above	Part Number	Hose Size	Number of Inserts	Weight (pounds)	Dimensions
A	80001A	1/2"	1	2.6	31" x 4"
B	800015A	3/4"	1	2.8	31" x 4"

For the operator's safety, this hose should not be used over 600 PSI.

CHAIN BREAKERS & CHAINS



The Difference Is Performance!

A chain breaker is a mechanical device used to "break" a chain in such a way it can be mended with the same tool. The chain comes with links and plates that are pinned together, and these pins can be pushed out with the chain tool. The chain breaker is used to cut the chain to the proper length needed for a particular size pipe.



CHAIN BREAKERS

Product Shown Above	Part Number	Usage	Weight (pounds)
A	0800064	Micro and Mini Chain Cutters	.65
B	0800069	150, 200, Super Nova	1.25



CHAINS

Product Shown Above	Part Number	Usage	Weight	Dimensions
A	G00200021	Micro and Mini Chain Cutters	2.25	5' of Chain
B	G00200022	150	14	15' of Chain
	G00200422	Super Nova and 200	15.45	15' of Chain

ACCESSORIES

Channel Cleaner is KEG's latest product innovation: our channel cleaners specially designed for efficient and trouble-free cleaning of channels from 90 - 200 mm in width.

ADVANTAGES & APPLICATIONS

- Efficient cleaning nozzle for increased water flow and better transport of deposits from the channels
- Less staff required for cleaning, as no water sprays on top of the drainage area
- Large version infinitely adjustable in width to fit channels from 150 - 200 mm



A

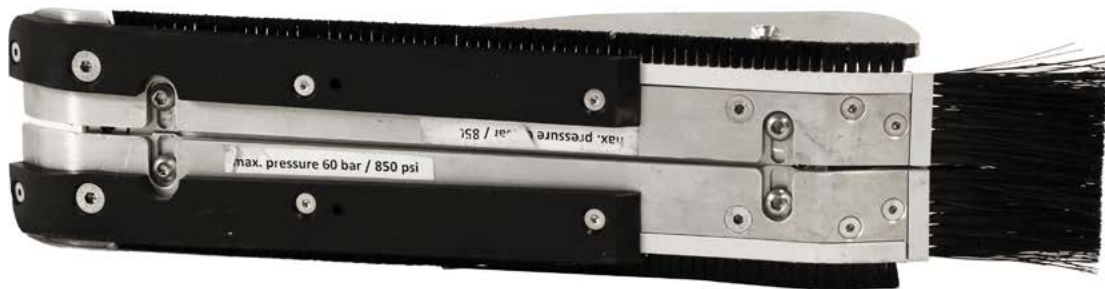

Product Shown Above	Part Number	Usage	Hose Size	Weight	Dimensions
A	101401	150 - 200 mm	3/4"	5.3	17 3/10" X 3 1/2"
B	101400	90 - 110 mm	3/4"	5.0	17 3/10" X 3 1/2"

SPREADER BAR



The Difference Is Performance!

The spreader bar is designed to keep the two floor cleaners from crossing paths within the piping system. It connects to the floor cleaners with the help of clevis hooks.



Product Shown Above	Part Number	Nozzle Usage	Weight (pounds)	Dimensions	Pipe Size
A	A00100119_Spread Bar	Floor Cleaners	6.4	30"	48" and Above

This accessory is for use on the floor cleaners. It adapts to clean the pipe side walls as the cleaner propels forward jetting away debris. It propels water at a 45-degree angles.

Angle Adaptors can also be turned upward to clean bridges within a pipe.

ANGLE ADAPTOR



Product Shown Above	Part Number	Nozzle Usage	Weight (pounds)	Dimensions
A	G00100184	Floor Cleaners	.1	2" x 3/4"

Y CONNECTOR

The Y connector is a necessary tool used in Twin Nozzle operation for larger pipes. This connection tool allows dual use for Floor Cleaners and OMG Nozzles.



Product Shown Above	Part Number	Hose Size	Weight (pounds)	Dimensions	Pipe Size
A	G00100126A	1" - 1 1/4"	8.1	20"	48" and Up
B	G00100126	1" - 1 1/4"	4.65	13"	48" and Up

ACCESSORIES

REPLACEMENT TUBE ASSEMBLY

The flow tube can become damaged, and a replacement may be necessary.

The flow tube is used to test the gallons per

minute (GPM) flow of jetter machines ranging from 1/2" - 1". This will ensure optimal flow is used before beginning the pipe cleaning process.



Product Shown Above	Part Number	Weight (pounds)	Dimensions	Pipe Size
A	Poly Carbonate Tube Assembly	9.55	8" x 48"	8"

TURBO ADAPTOR



The Difference Is Performance!



The Turbo Adaptor provides additional water flow increasing the jetting power idea for up hill operation.

This tool also can be used to increase GPM without changing inserts within the nozzle.

Product Shown Above	Part Number	Nozzle Usage	Hose Size	Weight (pounds)	Dimensions	Pipe Size
A	800001	Any Nozzle	1"	.8	1" x 2 3/4"	6" and Above

CLEVIS HOOKS



The clevis hook is a device used with the Twin Floor Cleaners. This tool is required to keep the Twin Floor Cleaners from rotating inside pipes. Two clevis hooks are needed for the connection of proper use.

Product Shown Above	Part Number	Nozzle Usage	Weight (pounds)	Dimensions
A	A00100119_ Clevis Hook	Floor Cleaners	.65	3 1/4" x 2 3/4"



A



B

PULLING EYE HOOKS

Pulling Eye Hooks are an excellent tool that assists nozzles out of a pipe or dislodges nozzles in pipes as needed.

Product Shown Above	Part Number	Thread Size	Weight (pounds)	Dimensions
A	G0080004	6 mm	.1	1 1/2" x 1"
B	A00800012	8 mm	.15	2" x 1 1/2"

ACCESSORIES

TWISTER REBUILD KIT

The Twister Nozzle is a great oscillating jet that removes grease, roots and clears blockages from pipes. The four rear jets propel the nozzle up the line while the forward oscillating jet goes to work clearing the blockage. After time and time again clearing blockages this heavy hitter could become worn down and the rebuild kit is all that is needed to keep this knockout of a nozzle in working order.

The Twister rebuild kit comes with the replacement pieces shown below for your Twister Nozzle.

For more information about the Twister Nozzle please see page 29.



TWISTER REBUILD KIT

Product Shown Above	Part Number	Hose Size	Weight (pounds)	Dimensions	Pipe Size
A	100009	3/8"	0.6	2" X 1 1/2"	2" to 6"



The Difference Is Performance!

KEG REGIONAL CONTACTS

Our Team Is Here For Yours!

We are proud to serve customers across the United States and around the world! If you're interested in scheduling training for your team

or have additional questions, don't hesitate to reach out to your local KEG Sales Manager. ***We're here to help!***

KEG Technologies - *The Difference Is Performance!*

*Inquiries sent to sales@kegtechnologies.net will notify the appropriate **Keg Technologies** team members for immediate attention.*

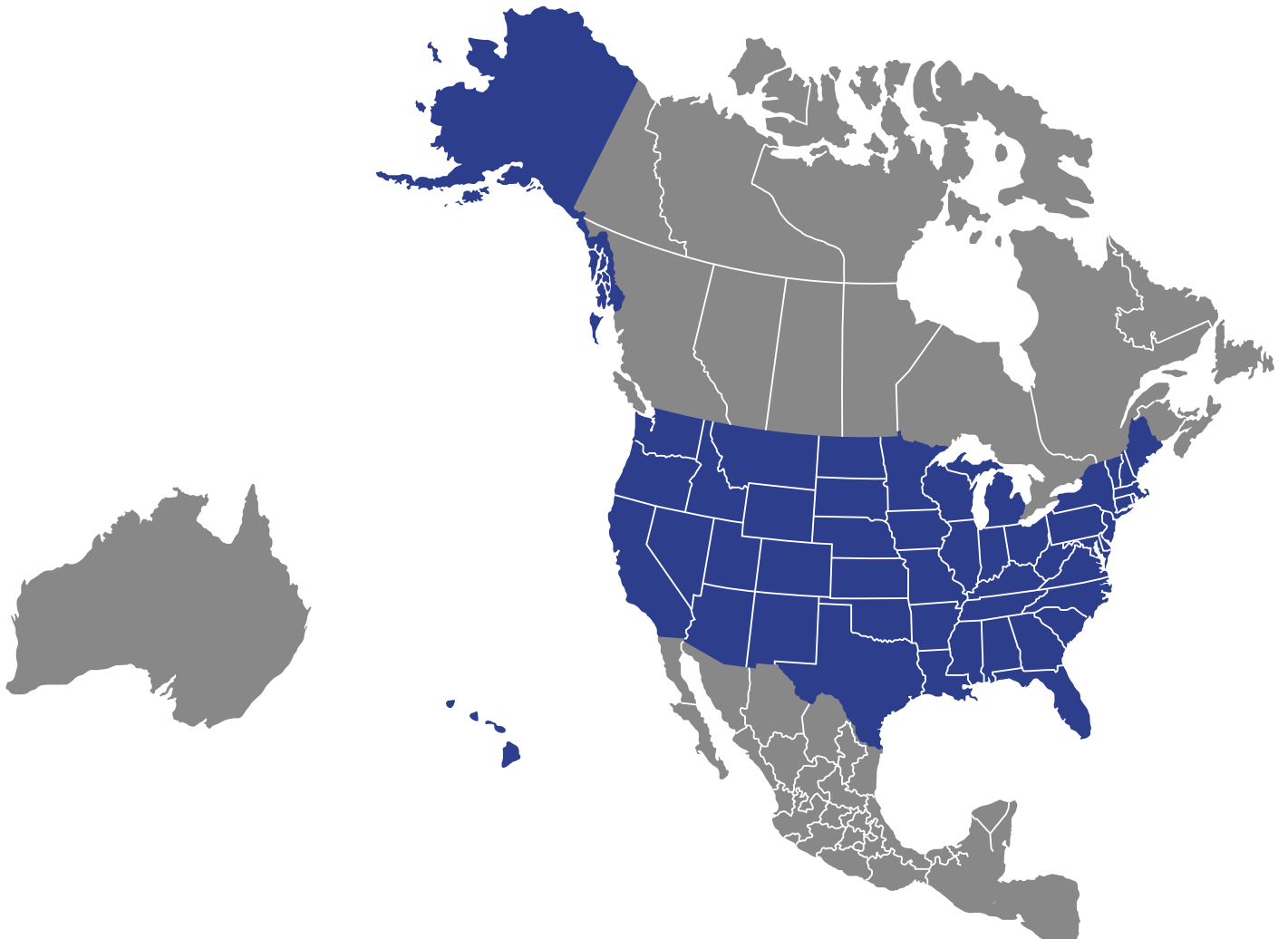

6220 North Pinnacle Drive • Spartanburg, SC 29303

kegnozzles.com |  KEGGMBH

Call toll free to order 1.866.595.0515



If you have questions, need assistance with a product, or want to schedule a training class, please contact the Keg Technologies office directly for help from a reseller or territory manager in your area.

*For immediate assistance, send your inquiries
to sales@kegtechnologies.net
or call our office directly at 864.804.6637
—our team is ready to help!*