

VACTOR[®] OEM Nozzles

VACTOR[®]
Subsidiary of Federal Signal Corporation

Welcome to the new lineup of Vactor® OEM Nozzles.

Now you have
all the tools to
get the job
done better
and faster!



The new line of Vactor OEM nozzles is bigger and better than ever ... with more punch, power and performance than you ever thought possible.



























- Premium performance at a economical price
- Fully replaceable and interchangeable inserts
- Wear-resistant tungsten carbide inserts
- Corrosion-resistant coatings, harder than stainless
- Nozzles that easily change from penetrating to flushing
- Rugged nozzles that traverse even the most irregular paths
- Special nozzles that can chew through roots in record time
- Nozzles that will even churn through concrete and minerals

Please explore our complete nozzle line — then contact your nearest dealer or Vactor service representative for help with ordering or specifying.

VACTOR®
Subsidiary of Federal Signal Corporation

815.672.3171
www.vactor.com

OEM Nozzle Table of Contents

<p>AGITATOR page 5</p> 	<p>STANDARD PENETRATOR page 18</p> 
<p>WEDGE page 6</p> 	<p>CHISEL POINT WEDGE page 19</p> 
<p>SUPER FLUSHER page 7</p> 	<p>THUNDER page 20</p> 
<p>POWER CLEANER page 8</p> 	<p>JPX page 21</p> 
<p>CRUISER™ page 9</p> 	<p>TWISTER page 22</p> 
<p>MAD FLUSHER™ page 10</p> 	<p>PIPE WOLF page 23</p> 
<p>P-15 PENETRATOR page 11</p> 	<p>ROOT CUTTER page 24</p> 
<p>GRENADE page 12</p> 	<p>TURBO CHAINCUTTER page 25</p> 
<p>COMMANDOR™ page 13</p> 	<p>MILLING CUTTER page 26</p> 
<p>PROBE page 14</p> 	<p>FLAT CULVERT page 27</p> 
<p>EG PENETRATOR page 15</p> 	<p>6 INCH CULVERT page 28</p> 
<p>STANDARD SANITARY page 16</p> 	<p>8 INCH CULVERT page 29</p> 
<p>STANDARD SAND page 17</p> 	<p>HYDROSURGE™ page 30</p> 

Use OEM nozzles for optimum performance and reliability. It's always your best value overall!

Welcome to the industry's best and most complete selection of nozzles for Vactor cleaning equipment.

Please review this page before using this catalog to specify or order products. We look forward to providing you with the best products and service to help you get the job done right.

When do my tools need service?

Signs of orifice wear:

- Orifices are as large or larger than the next drill size.
- System pressure cannot be achieved.

Signs of nozzle wear:

- Wear rings (where applicable) are worn down.
- Orifice, retainer, or chamber area has been breached.
- There is noticeable leakage from area other than the orifice.

All of these conditions require immediate attention and/or replacement.

Replacement Tungsten Carbide Inserts

(used in all Vactor OEM nozzles)

part #	size*
47337	0.050
47338	0.055
47339	0.060
47340	0.065
45071	0.070
45062	0.075
45044	0.080
44735	0.086
45043	0.090
44736	0.095
45055	0.100
44738	0.103
45056	0.105
45042	0.110
44740	0.116
45057	0.122
45068	0.130
45079	0.135
44741	0.140

Also Available

- 48964A Stainless Steel Retainer (each)
- 41848A Stainless Steel Penetrator Plug

*All sizes are in inches of diameter

Nozzle Labeling & Sizing

This chart is to be used for ordering a nozzle. It will match your system specifications for the nozzle style you request.

Extensive testing allows Vactor nozzles to be accurately sized to your system specifications. Your hose size, desired flow, and pump pressure are easily converted into the "lettering" system described at right.

Reorders and parts orders can be quickly placed and processed when providing part numbers and lettering.

Note: Nozzles are sized approximately 3-5 GPM below the specified flow rate to allow for wear.

 <small>Subsidiary of Federal Signal Corporation</small>	1st letter	2nd letter
	Hose dia. (in)	Flow (GPM)
	A = 1-1/4	A = 35
	B = 1	B = 40
	C = 3/4	C = 45
	D = 1-1/2	D = 50
		E = 55
	3rd letter	F = 60
	Pressure (psi)	G = 65
	A = 1850	H = 70
	B = 2000	I = 75
	C = 2500	J = 80
	D = 3000	K = 90
	L = 100	
	M = 120	
Made in USA		
Part No.	48980BJC	

WARNING

High pressure
 Operating tool outside of sewer line may result in serious injury or death. Sewer maintenance tools operate at high pressure. Position tool two feet into sewer line before operating. Build pressure slowly to ensure tool is positioned correctly. Turn off pressure source before removing tool from sewer line.

48902

Example: If you want a Wedge nozzle on 1" hose at 80 GPM and 2500 PSI — the product chart above indicates part number 48980BJC would be the part to order.

AGITATOR



APPLICATIONS

- Grease
- Scale
- Hair roots
- 360° coverage

TECHNICAL SPECIFICATIONS

- Work-hardened, low-carbon steel
- Outer coating harder than stainless
- Impregnated with heat-treated Teflon®
- Replaceable tungsten carbide inserts
- No lubrication required
- Numerous pressure and flow combinations

Rip through grease and scale with this high-powered rotating nozzle. Spinning action provides 360° pipe cleaning while the heat-treated Teflon-impregnated coating reduces shaft friction for increased wear resistance.

Part #	NPT Port Diameter	Part Description	1st Rear Angle	2nd Rear Angle	Spinning Angle	Nozzle Diameter	Nozzle Length	Nozzle Weight	Pipe Diameter
49023	3/4"	AGITATOR	6 @15°	none	2 @90°	2-1/4"	5"	3.8 lb	6"-12"
49670	1"	AGITATOR	6 @15°	none	2 @90°	2-1/2"	5-1/4"	4.8 lb	6"-20"
49025	1-1/4"	AGITATOR	6 @15°	none	2 @90°	2-3/4"	5-5/8"	6.1 lb	8"-24"

Nozzle Labeling & Sizing Example: If you want an Agitator nozzle on 1" hose at 80 GPM and 2500 PSI — the product chart on page 4 indicates part number 49002 BJC would be the part to order.

WEDGE



APPLICATIONS

- Accumulated debris
- Roots
- Ice
- Complete cleaning

TECHNICAL SPECIFICATIONS

- Work-hardened, low-carbon steel
- Outer coating harder than stainless
- Replaceable tungsten carbide inserts
- Stainless steel retainers
- Numerous pressure and flow combinations

This wedge shaped nozzle with multiple front jets cuts through large obstructions and the dirtiest of pipes. A virtual porcupine of jets reach out in all directions to easily knock out roots, ice, or a fully blocked line.

Part #	NPT Port Diameter	Part Description	1st Rear Angle	2nd Rear Angle	Front Angle	Nozzle Diameter	Nozzle Length	Nozzle Weight	Pipe Diameter
48979	3/4"	WEDGE	6 @20°	none	3 @20° 1 @0°	2-1/8"	4"	2.0 lb	4"-12"
48980	1"	WEDGE	6 @20°	none	3 @20° 1 @0°	2-3/8"	4-1/2"	2.7 lb	6"-16"
48981	1-1/4"	WEDGE	6 @20°	none	3 @20° 1 @0°	2-3/4"	4-3/4"	3.8 lb	6"-20"

Nozzle Labeling & Sizing Example: If you want a Wedge nozzle on 1" hose at 80 GPM and 2500 PSI — the product chart on page 4 indicates part number 48980BJC would be the part to order.

SUPER FLUSHER



APPLICATIONS

- General cleaning
- Navigates inclines
- Excellent coverage
- Sand, silt and gravel

TECHNICAL SPECIFICATIONS

- Work-hardened, low-carbon steel
- Outside coating harder than stainless
- Replaceable tungsten carbide inserts
- Stainless steel retainers
- Power-and-Scour jets
- Numerous pressure and flow combinations
- Dual degrees

When your job requires high thrust and effective cleaning, this 10-jet nozzle gets the job done. The Super Flusher's rugged cone shape assists forward travel while its power-maximizing internal cup diverts the jet spray backwards to flush out loose obstructions and debris.

Part #	NPT Port Diameter	Part Description	1st Rear Angle	2nd Rear Angle	Front Angle	Nozzle Diameter	Nozzle Length	Nozzle Weight	Pipe Diameter
49005	3/4"	SUPER FLUSHER	5 @10°	5 @25°	none	3"	5"	5.8 lb	6"-16"
49006	1"	SUPER FLUSHER	5 @10°	5 @25°	none	3-3/8"	6-1/8"	9.4 lb	6"-20"
49007	1-1/4"	SUPER FLUSHER	5 @10°	5 @25°	none	3-1/2"	6-1/4"	10.0 lb	6"-24"

Nozzle Labeling & Sizing Example: If you want a Super Flusher nozzle on 1" hose at 80 GPM and 2500 PSI — the product chart on page 4 indicates part number 49006BJC would be the part to order.

For additional service parts or more information, please contact your nearest dealer or Vactor Service Representative.

POWER CLEANER



APPLICATIONS

- General cleaning
- Light grease
- Sediment deposits
- Excellent coverage

TECHNICAL SPECIFICATIONS

- Work-hardened, low-carbon steel
- Outside coating harder than stainless
- Replaceable tungsten carbide inserts
- Stainless steel retainers
- Power-and-Scour jets
- Numerous pressure and flow combinations
- Dual degrees

The Power Cleaner is an 8-jet nozzle with great coverage and cleaning ability. The rugged cone shape assists with forward travel while its power-maximizing internal cup diverts the jet spray backwards to flush out unwanted dirt and debris.

Part #	NPT Port Diameter	Part Description	1st Rear Angle	2nd Rear Angle	Front Angle	Nozzle Diameter	Nozzle Length	Nozzle Weight	Pipe Diameter
49052	3/4"	POWER CLEANER	4 @15°	4 @25°	none	2-3/4"	5"	5.3 lb	6"-16"
49054	1"	POWER CLEANER	4 @15°	4 @25°	none	3"	5-1/2"	6.9 lb	6"-20"
49056	1-1/4"	POWER CLEANER	4 @15°	4 @25°	none	3-1/4"	6"	9.0 lb	6"-24"

Nozzle Labeling & Sizing Example: If you want a Power Cleaner nozzle on 1" hose at 80 GPM and 2500 PSI — the product chart on page 4 indicates part number 49054BJC would be the part to order.

CRUISER™



APPLICATIONS

- General cleaning
- Heavy debris removal
- Gravel
- Heavy sludge
- High thrust

TECHNICAL SPECIFICATIONS

- Work-hardened, low-carbon steel
- Outside coating harder than stainless
- Replaceable tungsten carbide inserts
- Stainless steel retainers
- Power-and-Scour jets
- Numerous pressure and flow combinations
- Dual degrees

The Cruiser is an 8-jet nozzle equipped for the toughest of jobs. The Cruiser's internal geometry utilizes a cone with a power-maximizing cup to divert the water toward the jets. This hefty nozzle will be more than happy to ride the bottom of the pipe and leave a clear path in its wake.

Part #	NPT Port Diameter	Part Description	1st Rear Angle	2nd Rear Angle	Front Angle	Nozzle Diameter	Nozzle Length	Nozzle Weight	Pipe Diameter
49085	1"	CRUISER	4 @12°	4 @18°	none	3-3/4"	7-1/2"	14.8 lb	8"-24"
49087	1-1/4"	CRUISER	4 @12°	4 @18°	none	4-1/4"	7-3/4"	17.1 lb	8"-24"

Nozzle Labeling & Sizing Example: If you want a Cruiser nozzle on 1" hose at 80 GPM and 2500 PSI — the product chart on page 4 indicates part number 49085BJC would be the part to order.

MAD FLUSHER™



APPLICATIONS

- All-around cleaning
- Heavy gravel and sludge
- Mud, sand and silt
- Ideal for storm lines
- Excellent coverage

TECHNICAL SPECIFICATIONS

- Work-hardened, low-carbon steel
- Outside coating harder than stainless
- Replaceable tungsten carbide inserts
- Stainless steel retainers
- Power-and-Scour jets
- Wear indicator rings
- Numerous pressure and flow combinations
- Dual degrees

The Mad Flusher lives up to its name with its heavy-duty construction and powerful spray action. High-angle jets spray surrounding pipe walls quickly in large pipes, while low-angle jets propel debris down the line for maximized cleaning effectiveness. Indicator rings reveal when the nozzle body is fully worn and ready to be replaced.

Part #	NPT Port Diameter	Part Description	1st Rear Angle	2nd Rear Angle	Front Angle	Nozzle Diameter	Nozzle Length	Nozzle Weight	Pipe Diameter
49066	1"	MAD FLUSHER	6 @22°	6 @32°	none	4"	8-1/8"	20.7 lb	12"-40"
49068	1-1/4"	MAD FLUSHER	6 @22°	6 @32°	none	4-1/2"	8-1/2"	28.3 lb	12"-40"

Nozzle Labeling & Sizing Example: If you want a Mad Flusher nozzle on 1" hose at 80 GPM and 2500 PSI — the product chart on page 4 indicates part number 49066BJC would be the part to order.

P-15 PENETRATOR

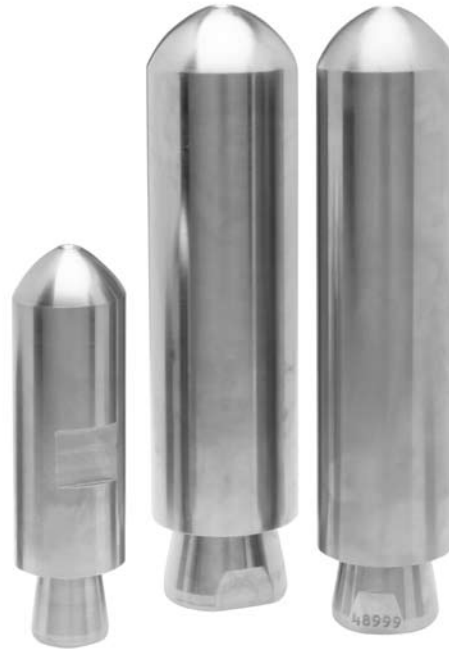

APPLICATIONS

- Removing blockages
- Sand, silt and gravel
- Broken pipes
- Disjointed, settled pipe

TECHNICAL SPECIFICATIONS

- Work-hardened, low-carbon steel
- Outside coating harder than stainless
- Replaceable tungsten carbide inserts
- Stainless steel retainers
- Penetrator and flusher modes
- Numerous pressure and flow combinations
- Front penetrator plug

The P-15 Penetrator's long, narrow body easily navigates small diameter pipes and traverses many treacherous conditions, such as broken or settled pipe. With the front nozzle port open, the P-15 Penetrator can bust through blockages with ease. When blockages are cleared, simply insert the front plug to convert the P-15 Penetrator to a flusher nozzle to finish the job.

Part #	NPT Port Diameter	Part Description	1st Rear Angle	2nd Rear Angle	Front Angle	Nozzle Diameter	Nozzle Length	Nozzle Weight	Pipe Diameter
49012	3/4"	P-15 PENETRATOR	6 @15°	none	1 @0°	2"	7"	4.3 lb	4"-12"
48999	1"	P-15 PENETRATOR	6 @15°	none	1 @0°	2-1/2"	11"	11.3 lb	6"-16"
49013	1-1/4"	P-15 PENETRATOR	6 @15°	none	1 @0°	2-3/4"	11"	12.9 lb	6"-16"

Nozzle Labeling & Sizing Example: If you want a P-15 Penetrator nozzle on 1" hose at 80 GPM and 2500 PSI — the product chart on page 4 indicates part number 48999BJC would be the part to order.

For additional service parts or more information, please contact your nearest dealer or Vector Service Representative.

GRENADE



APPLICATIONS

- General maintenance
- Removing blockages
- Sand
- Silt
- Gravel

TECHNICAL SPECIFICATIONS

- Work-hardened, low-carbon steel
- Outside coating harder than stainless
- Replaceable tungsten carbide inserts
- Penetrator and Flusher modes
- Numerous pressure and flow combinations
- Front penetrator plug

Toss this nozzle down a line and watch it blast through blockages. The Grenade is a small nozzle that packs a punch when used in small diameter pipe. This 2-in-1 nozzle provides powerful penetration for clearing obstructions head on. Insert the front plug and the low-angle jets now provide perfect flushing action to wash out debris, sand and gravel.

Part #	NPT Port Diameter	Part Description	1st Rear Angle	2nd Rear Angle	Front Angle	Nozzle Diameter	Nozzle Length	Nozzle Weight	Pipe Diameter
49027	3/4"	GRENADE	5 @12°	none	1 @0°	2-1/4"	3-3/4"	2.4 lb	4"-12"
49029	1"	GRENADE	5 @12°	none	1 @0°	2-1/2"	4"	3.1 lb	6"-12"
49031	1-1/4"	GRENADE	5 @12°	none	1 @0°	2-3/4"	4-1/4"	3.5 lb	6"-12"

Nozzle Labeling & Sizing Example: If you want a Grenade nozzle on 1" hose at 80 GPM and 2500 PSI — the product chart on page 4 indicates part number 49029BJC would be the part to order.

For additional service parts or more information, please contact your nearest dealer or Vactor Service Representative.

COMMANDOR™



APPLICATIONS

- General maintenance
- Removing blockages
- Cleaning larger pipes
- Sand, silt and gravel
- Sludge

TECHNICAL SPECIFICATIONS

- Work-hardened, low-carbon steel
- Outside coating harder than stainless
- Replaceable tungsten carbide inserts
- Power-and-Scour jets
- Penetrator and Flusher Modes
- Friction reduced 15% over similar nozzles
- Dual degrees
- Front penetrator plug

The Commandor is a proven jack-of-all-trades nozzle with a multi-functional design that can do it all. It is the only Vector OEM penetrator-style nozzle equipped with dual-angle jets — one set of jets aimed high for maximum cleaning and the other jets aimed low for effective flushing and thrust. Outer rails provide dual scraping action while allowing underbelly flow. Penetrate through the worst of blockages, or plug the front orifice to convert to flushing mode and fly down the pipe effortlessly.

Part #	NPT Port Diameter	Part Description	1st Rear Angle	2nd Rear Angle	Front Angle	Nozzle Diameter	Nozzle Length	Nozzle Weight	Pipe Diameter
49033	3/4"	COMMANDOR	4 @15°	4 @35°	1 @0°	3"	5"	5.1 lb	6"-20"
49035	1"	COMMANDOR	5 @15°	5 @35°	1 @0°	3-1/2"	5-1/2"	7.7 lb	8"-24"
49037	1-1/4"	COMMANDOR	5 @15°	5 @35°	1 @0°	4"	6"	11.0 lb	8"-24"

Nozzle Labeling & Sizing Example: If you want a Commandor nozzle on 1" hose at 80 GPM and 2500 PSI — the product chart on page 4 indicates part number 49035BJC would be the part to order.

PROBE



APPLICATIONS

- General maintenance
- Open, obstructed pipe
- Long runs
- Mud and silt
- Medium pipe diameters

TECHNICAL SPECIFICATIONS

- Work-hardened, low-carbon steel
- Outside coating harder than stainless
- Replaceable tungsten carbide inserts
- Penetrator and flusher modes
- Numerous pressure and flow combinations
- Probe tip
- Front penetrator plug

Show no mercy to blockages and punch your way through obstructions with the Probe's penetrator jet and probing tip. Perform final cleaning by changing the front penetrator tip for the front penetrator plug, effectively changing the nozzle into a flusher with one simple adjustment.

Part #	NPT Port Diameter	Part Description	1st Rear Angle	2nd Rear Angle	Front Angle	Nozzle Diameter	Nozzle Length	Nozzle Weight	Pipe Diameter
49078	3/4"	PROBE	5 @15°	none	1 @0°	2"	6-3/4"	2.2 lb	4"-12"
44228	1"	PROBE	5 @15°	none	1 @0°	2"	6-3/4"	2.2 lb	4"-16"
49080	1-1/4"	PROBE	5 @15°	none	1 @0°	2-1/2"	7-1/8"	3.5 lb	6"-16"

Nozzle Labeling & Sizing Example: If you want a Probe nozzle on 1" hose at 80 GPM and 2500 PSI — the product chart on page 4 indicates part number 44228BJC would be the part to order.

For additional service parts or more information, please contact your nearest dealer or Vactor Service Representative.

EG PENETRATOR



APPLICATIONS

- Penetrate obstructions
- Long runs
- Steep grades
- Mud, silt, sand and gravel
- Discontinuous, settled pipe

TECHNICAL SPECIFICATIONS

- Work-hardened, low-carbon steel
- Outside coating harder than stainless
- Replaceable tungsten carbide inserts
- Penetrator and flusher modes
- Numerous pressure and flow combinations
- Front penetrator plug

This egg-shaped nozzle is sure to get down the line and back again without hang-ups. With 8-degree, low-angle jets and front penetrating port, this sleek nozzle can easily get to some of the farthest blockages in need of removal. The EG Penetrator can also convert quickly to flushing mode by inserting its front plug.

Part #	NPT Port Diameter	Part Description	1st Rear Angle	2nd Rear Angle	Front Angle	Nozzle Diameter	Nozzle Length	Nozzle Weight	Pipe Diameter
49058	3/4"	EG PENETRATOR	6 @8°	none	1 @0°	2-1/2"	4-1/4"	3.1 lb	4"-12"
49060	1"	EG PENETRATOR	6 @8°	none	1 @0°	2-3/4"	4-1/2"	4.2 lb	6"-12"
49062	1-1/4"	EG PENETRATOR	6 @8°	none	1 @0°	3"	4-3/4"	5.2 lb	6"-12"

Nozzle Labeling & Sizing Example: If you want a EG Penetrator nozzle on 1" hose at 80 GPM and 2500 PSI — the product chart on page 4 indicates part number 49060BJC would be the part to order.

For additional service parts or more information, please contact your nearest dealer or Vactor Service Representative.

STANDARD SANITARY



APPLICATIONS

- General maintenance
- Sanitary
- Silt
- Mud
- Gravel

TECHNICAL SPECIFICATIONS

- Work-hardened, low-carbon steel
- Outside coating harder than stainless
- Replaceable tungsten carbide inserts
- Numerous pressure and flow combinations

The Standard Sanitary nozzle is one of Vactor's most popular nozzles, along with the Standard Sand and Standard Penetrator models. These rugged nozzles are excellent for most applications, from cleaning to penetrating and flushing. Now available with a NEW corrosion-resistant and abrasion-resistant coating as well as the NEW replaceable orifice style, these models continue to be an easy choice whenever a robust, hard-working nozzle is needed.

Part #	NPT Port Diameter	Part Description	1st Rear Angle	2nd Rear Angle	Front Angle	Nozzle Diameter	Nozzle Length	Nozzle Weight	Pipe Diameter
60306	1"	15° SANITARY	6 @15°	none	none	2-3/8"	4-1/2"	3.3 lb	6"-12"
58756	1"	30° SANITARY	6 @30°	none	none	2-3/8"	4-1/4"	3.2 lb	6"-16"
48973	1-1/4"	15° SANITARY	6 @15°	none	none	2-3/4"	4-3/4"	4.7 lb	6"-16"
48976	1-1/4"	30° SANITARY	6 @30°	none	none	2-3/4"	4"	3.9 lb	6"-20"

Nozzle Labeling & Sizing Example: If you want a 15° Standard Sanitary nozzle on 1" hose at 80 GPM and 2500 PSI — the product chart on page 4 indicates part number 60306BJC would be the part to order.

STANDARD SAND



APPLICATIONS

- General maintenance
- Sand
- Mud
- Gravel

TECHNICAL SPECIFICATIONS

- Work-hardened, low-carbon steel
- Outside coating harder than stainless
- Replaceable tungsten carbide inserts
- 2 front penetrators
- Numerous pressure and flow combinations

The Standard Sand nozzle is one of Vactor's most popular nozzles, along with the Standard Sanitary and Standard Penetrator models. These rugged nozzles are excellent for most applications, from cleaning to penetrating and flushing. Now available with a NEW corrosion-resistant and abrasion-resistant coating as well as the NEW replaceable orifice style, these models continue to be an easy choice whenever a robust, hard-working nozzle is needed.

Part #	NPT Port Diameter	Part Description	1st Rear Angle	2nd Rear Angle	Front Angle	Nozzle Diameter	Nozzle Length	Nozzle Weight	Pipe Diameter
60307	1"	15° SAND	6 @15°	none	2 @30°	2-3/8"	5-1/8"	3.4 lb	6"-12"
58926	1"	30° SAND	6 @30°	none	2 @30°	2-3/8"	7-7/8"	3.3 lb	6"-16"
48974	1-1/4"	15° SAND	6 @15°	none	2 @30°	2-3/4"	5-5/6"	4.8 lb	6"-16"
48977	1-1/4"	30° SAND	6 @30°	none	2 @30°	2-3/4"	4-7/8"	4.0 lb	6"-20"

Nozzle Labeling & Sizing Example: If you want a 15° Standard Sand nozzle on 1" hose at 80 GPM and 2500 PSI — the product chart on page 4 indicates part number 60307BJC would be the part to order.

For additional service parts or more information, please contact your nearest dealer or Vactor Service Representative.

STANDARD PENETRATOR



APPLICATIONS

- General maintenance
- Silt
- Mud
- Gravel
- Blockages

TECHNICAL SPECIFICATIONS

- Work-hardened, low-carbon steel
- Outside coating harder than stainless
- Replaceable tungsten carbide inserts
- 1 front penetrator
- Numerous pressure and flow combinations

The Standard Penetrator nozzle is one of Vactor's most popular nozzles, along with the Standard Sanitary and Standard Sand models. These rugged nozzles are excellent for most applications, from cleaning to penetrating and flushing. Now available with a NEW corrosion-resistant and abrasion-resistant coating as well as the NEW replaceable orifice style, these models continue to be an easy choice whenever a robust, hard-working nozzle is needed.

Part #	NPT Port Diameter	Part Description	1st Rear Angle	2nd Rear Angle	Front Angle	Nozzle Diameter	Nozzle Length	Nozzle Weight	Pipe Diameter
60308	1"	15° PENETRATOR	6 @15°	none	1 @0°	2-3/8"	4-1/2"	3.2 lb	6"-12"
58927	1"	30° PENETRATOR	6 @30°	none	1 @0°	2-3/8"	4-1/4"	3.1 lb	6"-16"
48975	1-1/4"	15° PENETRATOR	6 @15°	none	1 @0°	2-3/4"	4-3/4"	4.7 lb	6"-16"
48978	1-1/4"	30° PENETRATOR	6 @30°	none	1 @0°	2-3/4"	4"	3.9 lb	6"-20"

Nozzle Labeling & Sizing Example: If you want a 15° Standard Penetrator nozzle on 1" hose at 80 GPM and 2500 PSI — the product chart on page 4 indicates part number 60308BJC would be the part to order.

CHISEL POINT WEDGE



APPLICATIONS

- General maintenance
- Large obstructions
- Root masses
- Gravel and sand
- Sludge

TECHNICAL SPECIFICATIONS

- Tempered stainless steel
- Replaceable ceramic inserts
- Changeable front tip
- All orifices rated for 2000/2500 PSI

These Chisel nozzles provide excellent performance in difficult cleaning situations, especially when pipe deformations or total blockages are present. The different forward-jet options and sharp edges assure fast and reliable cleaning. Our chisel nozzles with forward jets and drill points penetrate deeply to remove and flush total blockages.

Part #	NPT Port Diameter	Flow Rate	1st Rear Angle	2nd Rear Angle	Front Angle	Front Tip Angle	Nozzle Diameter	Nozzle Length	Nozzle Weight	Pipe Diameter
500015BB	3/4"	40 GPM	6 @22°	none	3 @15° forward	3 @45° rearward	2"	5-3/4"	4.5 lb	4"-12"
500015BC	3/4"	50 GPM	6 @22°	none	3 @15° forward	3 @45° rearward	2"	5-3/4"	4.5 lb	4"-12"
500015AC	1"	60 GPM	6 @22°	none	4 @15° forward	2 @45° rearward	2-7/8"	7-3/4"	5.5 lb	8"-16"
500015AE	1"	80 GPM	6 @22°	none	4 @15° forward	2 @45° rearward	2-7/8"	7-3/4"	5.5 lb	8"-24"
500015C	1-1/4"	60 GPM	6 @22°	none	4 @15° forward	2 @45° rearward	2-7/8"	7-3/4"	5.5 lb	8"-16"
500015E	1-1/4"	80 GPM	6 @22°	none	4 @15° forward	2 @45° rearward	2-7/8"	7-3/4"	5.5 lb	8"-24"
500015F	1-1/4"	100 GPM	6 @22°	none	4 @15° forward	2 @45° rearward	2-7/8"	7-3/4"	5.5 lb	12"-36"

For additional service parts or more information, please contact your nearest dealer or Vactor Service Representative.

THUNDER



APPLICATIONS

- Blockages
- Sand, silt and gravel
- Steep grades

TECHNICAL SPECIFICATIONS

- Stainless steel construction
- Stainless steel skid
- Powdercoated body
- Available in Penetrator and Flusher versions

With the Thunder nozzle, exceptional power and performance come standard. The low-angle jets are essential for traveling steep grades and are focused rearward.

Part #	NPT Port Diameter	Flow Rate	1st Rear Angle	2nd Rear Angle	Front Angle	Nozzle Diameter	Nozzle Length	Nozzle Weight	Pipe Diameter
83107S	3/4"	40 GPM	6 @10°	none	none	4-3/4"	9-1/2"	4.0 lb	6"-12"
83107T	3/4"	60 GPM	6 @10°	none	none	4-3/4"	9-1/2"	4.0 lb	8"-12"
83107C	1"	40 GPM	6 @10°	none	none	5"	11"	9.0 lb	8"-16"
83107D	1"	40 GPM	6 @10°	none	1 @0°	5"	11"	9.0 lb	8"-16"
83107E	1"	60 GPM	6 @10°	none	none	5"	11"	9.0 lb	8"-16"
83107F	1"	60 GPM	6 @10°	none	1 @0°	5"	11"	9.0 lb	8"-16"
83107G	1"	80 GPM	6 @10°	none	none	5"	11"	9.0 lb	8"-16"
83107H	1"	80 GPM	6 @10°	none	1 @0°	5"	11"	9.0 lb	8"-16"

JPX



APPLICATIONS

- General maintenance
- Removing blockages
- Sand and silt
- Gravel

TECHNICAL SPECIFICATIONS

- Stainless steel construction
- Complete set of Flusher Inserts
- Complete set of Penetrator Inserts
- 8-inch diameter stainless steel skid

The low-angle jets and the rugged stainless steel construction of the JPX nozzle provide excellent penetration and flushing with a single, highly durable nozzle. This model is provided with a full package of inserts to quickly and easily change between penetration and flushing modes. Stainless steel skids surrounding the JPX body greatly reduce body wear to provide long-term performance.

Part #	NPT Port Diameter	Flow Rate	1st Rear Angle	2nd Rear Angle	Front Angle	Nozzle Diameter	Nozzle Length	Nozzle Weight	Pipe Diameter
82882	1"	60 GPM	6 @15°	none	1 @0°	3-1/2"	6"	5.0 lb	8"-16"
83107	1"	80 GPM	6 @15°	none	1 @0°	3-1/2"	6"	5.0 lb	8"-16"

TWISTER

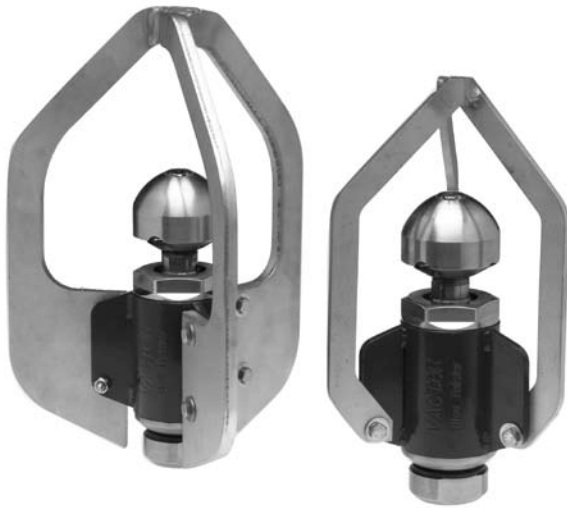

APPLICATIONS

- Grease
- Roots
- Obstructions
- Sand
- Silt

TECHNICAL SPECIFICATIONS

- Stainless steel construction
- 3-fin centralizer
- 15-degree offset penetrator
- Controlled spin from 150 to 300 RPM
- Replaceable attack tips
- 2 interchangeable abrasion-resistant skids
- Service kit

The Twister nozzle delivers powerful jets with a controlled rotation for unmatched cleaning power. Vactor's exclusive 3-fin design centers the nozzle within the lines and serves as a rugged skid that protects the nozzle from wear. The Twister nozzle comes with 2 skids for 8" and 12" (and larger) lines. Each nozzle comes with a service kit to help optimize your uptime and productivity.

Part #	NPT Port Diameter	Part Description	1st Rear Angle	2nd Rear Angle	Front Angle	Nozzle Diameter	Nozzle Length	Nozzle Weight	Pipe Diameter
89078	1"	TWISTER 60@2000	2 @30°	2 @45°	1 @15°	4-1/4"	9-1/8"	10.9 lb	8"-24"
89078A	1"	TWISTER 60@2500	2 @30°	2 @45°	1 @15°	4-1/4"	9-1/8"	10.9 lb	8"-24"
89079	1"	TWISTER 80@2000	2 @30°	2 @45°	1 @15°	4-1/4"	9-1/8"	10.9 lb	8"-36"
89079A	1"	TWISTER 80@2500	2 @30°	2 @45°	1 @15°	4-1/4"	9-1/8"	10.9 lb	8"-36"
49096	1-1/4"	TWISTER 100@2000	6 @40°	none	1 @15°	4-1/4"	9-1/8"	11.0 lb	8"-36"

4-fin style (w/o additional centralizer)

Part #	NPT Port Diameter	Flow Rate
49098	3/8"	10 GPM @3000 PSI
49098A	1/2"	18 GPM @4000 PSI
49098B	3/4"	40 GPM @2000 PSI

Service Parts

Part #	Description
48244	Service Kit, Twister 1"
48244A	Service Kit, Twister, 1-1/4"

PIPE WOLF



APPLICATIONS

- Blockages
- Total obstruction
- Heavy roots
- Grease
- Silt

TECHNICAL SPECIFICATIONS

- Tempered stainless steel
- Aggressive cutting head
- Replaceable ceramic inserts
- 6,000 RPM turbine-driven head
- No lubrication required

This unique cutter is driven by a turbine at 6,000 to 10,000 RPM to produce superior cleaning action suited to the most extreme applications. Where standard hydrodynamic tools fail, the Pipe Wolf will chew away blockages and total obstructions in no time, thus, keeping your productivity and operating costs on the perfect path.

Part #	NPT Port Diameter	Flow Rate	1st Rear Angle	2nd Rear Angle	Front Angle	Nozzle Diameter	Nozzle Length	Nozzle Weight	Pipe Diameter
48995	1"	60 GPM	6 @25°	none	3 @90°	2-3/4"	6-1/2"	4.0 lb	6"-15"
48996	1"	80 GPM	6 @25°	none	3 @90°	2-3/4"	6-1/2"	4.0 lb	6"-15"

ROOT CUTTER

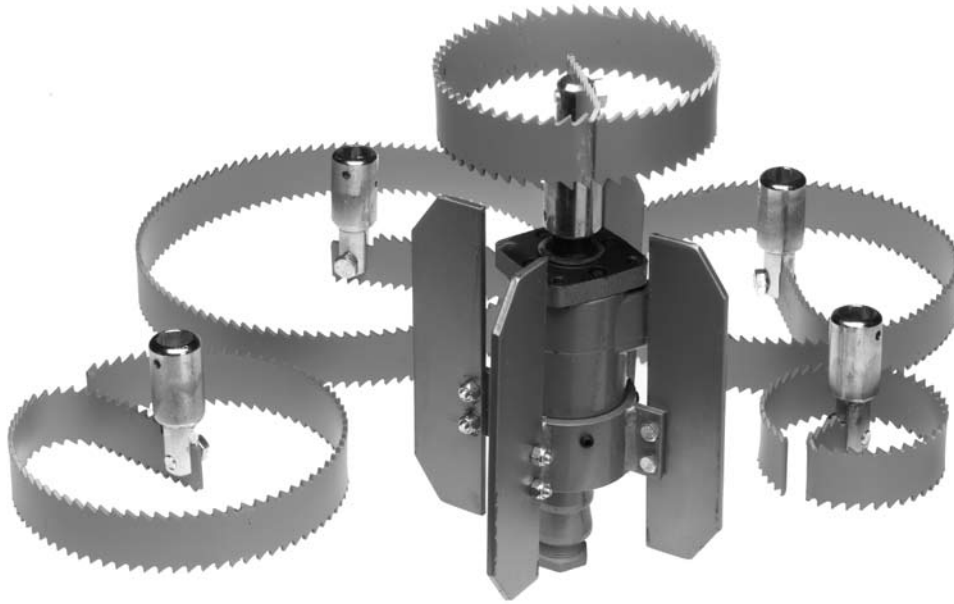

APPLICATIONS

- Heavy roots
- Grease
- Scale

TECHNICAL SPECIFICATIONS

- Includes motor & thruster assembly
- Includes maintenance tools
- 6", 8", 10", 12" and 15" skids
- 6", 8", 10", 12" and 15" root saws

The Root Cutter is a versatile tool for cutting roots, grease and scale in a wide range of pipe sizes. The cutter kit provides every accessory needed to tackle it all, including saws and skids for pipes from 6" to 15". With its high-powered motor and thruster, this tool saws through the toughest root masses in record time.

Part #	NPT Port Diameter	Part Description	1st Rear Angle	2nd rear Angle	Front Angle	Nozzle Diameter	Nozzle Length	Nozzle Weight	Pipe Diameter
501094	1"	ROOT CUTTER	N/A	none	none	4-1/8"	10-1/2"	13.0 lb	6"-15"

Replacement Saws

Part #	Description
43517	6" Spiral Flat Saw
43518	8" Spiral Flat Saw
43519	10" Spiral Flat Saw
43520	12" Spiral Flat Saw
43521	15" Spiral Flat Saw

TURBO CHAINCUTTER



APPLICATIONS

- Total blockages
- Extensive root growth
- Calcium deposits
- Grease
- Scale
- Mineral deposits

TECHNICAL SPECIFICATIONS

- Tempered stainless steel
- Turbine-driven head
- Replaceable ceramic inserts
- Changeable chains and chain retainers
- Usable with recycled water
- No lubrication required
- Continuously adjustable skid:
 - Turbo 2: 6" to 12"
 - Turbo 3: 10" to 20"

This innovative, highly reliable and efficient cutter offers superior drive and thrust to work through the toughest and hardest obstructions. The chain retainer is driven by a high-performance turbine that provides unsurpassed results in the removal of roots, grease and mineral deposits.

Part #	NPT Port Diameter	Part Description	1st Rear Angle	2nd Rear Angle	Spinning Angle	Nozzle Diameter	Nozzle Length	Nozzle Weight	*Pipe Diameter
500247A	1"	TURBO 2 CHAINCUTTER	6 @25°	none	3 @22°	5-1/2"	N/A	16.5 lb	6"-12"
502048	1"	TURBO 3 CHAINCUTTER	6 @25°	none	3 @22°	5-1/2"	N/A	43.0 lb	10"-20"

* Larger pipe diameters can be achieved through the use of extensions.

Additional Chain

Part #	Description
500247AJ	Replacement Chain (Turbo 2)
502048A	Replacement Chain (Turbo 3)

MILLING CUTTER



APPLICATIONS

- Hardened grease
- Calcium scale
- Concrete and mortar
- Tuberculation
- Protruding taps
- Heavy roots
- Failed liners

TECHNICAL SPECIFICATIONS

- Standard carbide bits
- Optional diamond bits
- 6" to 20" cutting head
- Sealed stainless steel drive
- Ceramic inserts
- Smooth spinning, non-percussion head
- No lubrication required

With one nozzle, your worst nightmares can be defeated. Whether you have protruding taps, failed liners, or mortar in your path, these Milling Cutters will clear the way. With carbide or diamond bits and a non-percussion cutting head, the Milling Cutter is the best tool for the most demanding jobs.

Part #	NPT Port Diameter	Flow Rate	Rear Inserts	Spinning Inserts	Nozzle Diameter	Nozzle Length	Nozzle Weight	Pipe Diameter
500022	1"	60-80 GPM	(4) 48668A	(4) 48668	5.4"	14"	26 lb	6"
500023	1"	60-80 GPM	(4) 48668A	(4) 48668	6.2"	14"	30 lb	8"
500024	1"	60-80 GPM	(4) 48668A	(4) 48668	7.3"	16"	34 lb	8"
500025	1"	60-80 GPM	(4) 48668A	(4) 48668	8.9"	16"	42 lb	10"
500026	1"	80 GPM	(4) 48668A	(4) 48668	11.3"	18"	42 lb	12"
500415	1"	80 GPM	(4) 48668A	(4) 48668	14.4"	20"	80 lb	15"-16"
500416	1"	80 GPM	(4) 48668A	(4) 48668	17.0"	29"	109 lb	18"
500417	1"	80 GPM	(4) 48668A	(4) 48668	19.0"	29"	111 lb	20"

Additional Bits

Part #	Description
500016C	Carbide Bit
500016K	Carbide Center Bit
500016W	Diamond Bit
5000747	Diamond Center Bit

For additional service parts or more information, please contact your nearest dealer or Vactor Service Representative.

FLAT CULVERT



APPLICATIONS

- Box culverts
- Flat pipe
- Silt and sand
- Sludge

TECHNICAL SPECIFICATIONS

- Steel construction
- Abrasion resistant
- Wear strips
- Replaceable carbide jets

The Flat Culvert is one of the industry's most preferred and economical nozzle. The water manifold and the carbide jets are symmetrically positioned, allowing the nozzle to always run efficiently in the culvert pipe.

Part #	Hose Diameter	Part Description	GPM	PSI	Rear Inserts	Nozzle Length	Nozzle Width	Nozzle Height	Nozzle Weight	Pipe Diameter
54608A	1-1/4"	FLAT CULVERT NOZZLE	50	2000	(8) 58005	16"	10"	3"	41 lb	16"-48"
54608B	1-1/4"	FLAT CULVERT NOZZLE	60	2000	(8) 58006	16"	10"	3"	41 lb	16"-48"
54608C	1-1/4"	FLAT CULVERT NOZZLE	80	2000	(8) 58008	16"	10"	3"	41 lb	16"-48"
54608D	1-1/4"	FLAT CULVERT NOZZLE	90	2000	(8) 58014	16"	10"	3"	41 lb	16"-48"

6 INCH CULVERT



APPLICATIONS

- Large pipes
- Heavy debris
- Silt and sand
- Sludge

TECHNICAL SPECIFICATIONS

- Steel construction
- Wear plate with tungsten carbide
- 60° front nose
- Tungsten carbide jets
- 5° - 10° jets

The 6 Inch Culvert Nozzle has a specially designed water manifold with 8 tungsten carbide inserts to provide an even thrust for maximum cleaning performance.

Part #	Hose Diameter	Part Description	GPM	PSI	Rear Inserts	Nozzle Diameter	Nozzle Length	Nozzle Weight	Pipe Diameter
54800A	1"	6" CULVERT NOZZLE	50	2000	(8) 58005	6"	17"	47 lb	12"-48"
54800B	1"	6" CULVERT NOZZLE	60	2000	(8) 58006	6"	17"	47 lb	12"-48"
54800C	1"	6" CULVERT NOZZLE	80	2000	(8) 58008	6"	17"	47 lb	12"-48"
54800D	1"	6" CULVERT NOZZLE	100	2000	(8) 58010	6"	17"	47 lb	12"-48"

8 INCH CULVERT



APPLICATIONS

- Large pipes
- Heavy debris
- Silt and sand
- Sludge

TECHNICAL SPECIFICATIONS

- Steel construction
- Bottom wear plate
- Tungsten carbide skids
- Tungsten carbide jets

Designed to tackle the most difficult obstruction, the specially designed water manifold and the 8 tungsten carbide inserts give you one of the industry's best cleaners.

Part #	Hose Diameter	Part Description	GPM	PSI	Rear Inserts	Nozzle Diameter	Nozzle Length	Nozzle Weight	Pipe Diameter
54590A	1"-1 1/4"	8" CULVERT NOZZLE	80	2000	(8) 60001	8"	25"	80 lb	15"-60"
54590B	1"-1 1/4"	8" CULVERT NOZZLE	100	2000	(8) 58010	8"	25"	80 lb	15"-60"
54590C	1"-1 1/4"	8" CULVERT NOZZLE	140	2000	(8) 58010	8"	25"	80 lb	15"-60"

HYDROSURGE™



APPLICATIONS

- Large pipe
- Storm water pipe
- Heavy debris
- Compact sand
- Dense silt
- Compressed sludge
- Under water

TECHNICAL SPECIFICATIONS

- Stainless steel construction
- Rollover bars
- Stainless steel swivel joint
- Ceramic inserts
- Hydro-force system
- Adjustable manifold
- 0-20° jet angle
- 6, 8, 10, 12 jets

The HydroSurge™ is the ultimate, high-performance cleaning nozzle for large pipe applications. The adjustable nozzle plate provides incredible traction and cleaning performance. The cleaning mode of 15 to 20 degrees removes heavy deposits from the bottom of the pipe.

Part #	NPT Port Diameter	Pipe Diameter	Part Description	GPM	Rear Inserts	Nozzle Length	Nozzle Height	Nozzle Weight
49460A	1-1/4"	32"-98"	HYDROSURGE	100	(12) 49535B	30"	13"	107 lb
49460B	1-1/4"	32"-98"	HYDROSURGE	100	(12) 49535C	30"	13"	107 lb
49461A	1-1/4"	24"-60"	HYDROSURGE	80	(10) 49535A	23"	10"	70 lb
49461B	1-1/4"	24"-60"	HYDROSURGE	80	(10) 49535C	23"	10"	70 lb
49462A	1"	16"-48"	HYDROSURGE	60	(8) 49535	21"	8.5"	55 lb
49462B	1"	16"-48"	HYDROSURGE	60	(8) 49535B	21"	8.5"	55 lb
49462C	1"	16"-48"	HYDROSURGE	80	(8) 49535D	21"	8.5"	55 lb
49462D	1"	16"-48"	HYDROSURGE	80	(8) 49535F	21"	8.5"	55 lb
49463A	1"	10"-24"	HYDROSURGE	45	(8) 49535	16"	7.5"	33 lb
49463B	1"	10"-24"	HYDROSURGE	45	(6) 49535B	16"	7.5"	33 lb
49463C	1"	10"-24"	HYDROSURGE	50	(6) 49535B	16"	7.5"	33 lb
49463D	1"	10"-24"	HYDROSURGE	50	(6) 49535C	16"	7.5"	33 lb

Your Vactor dealer is



Vactor Manufacturing, Inc.
1621 South Illinois Street
Streator, IL 61364
U.S.A

Tel: 815.672.3171
Fax: 815.672.2779
www.vactor.com

Effective 8/09
Specifications subject to change without notice.

©2009 Vactor Manufacturing, Inc. All rights reserved.
VACTOR is a registered tradename of Federal Signal Corporation.
Federal Signal Corporation is listed on the NYSE by the symbol FSS.

P/N 00088-C